



LANGUAGES



INSTRUCTION MANUAL



JAMBO™ 2021 XP 6S

C-00166 • Instruction Manual - Revised : 2022-07-29

Download the latest version of the manual as well as other languages from www.corally.com.



www.corally.com

INTRODUCTION • QUICK START GUIDE



Thank you for purchasing a Team Corally car. This manual describes the instructions for using the model and the electronic components. You will also find some tips on how to maintain your RC model so that you can enjoy it for years to come. You have purchased one of the most efficient models available on the market that has been designed by a team of professionals. You will also benefit from the best after-sales support. All Team Corally models guarantee a high quality of manufacture and performance that guarantees you a high satisfaction of use and services provided by the Team Corally. Always take the time to read the instructions carefully in order to follow all the procedures to use your RC model safely for you and for other people and property in the area. This will allow you to take full advantage of all the performance of your RC model.

Please also check the website www.corally.com/Downloads/ to check if you have the latest version of this instruction manual. (Version: see bottom cover of this manual)

If you have any questions about the model and its components, you can send a message to info@corally.com

We also recommend that you get help from an experienced model maker or your dealer.

You will find all the references of the spare parts on the website www.corally.com

TERM OF USE

The user is responsible for the use of your model. The user assumes all risks associated with the use of the model. This model is not intended for use by children under 14 years of age without the supervision of a responsible adult who is familiar with the dangers of using a RC model. Team Corally / JSP Group Intl bvba, its manufacturers, distributors and resellers cannot control the use and load of the model and therefore cannot be held responsible for any damage to property and damage caused to persons resulting from the use of this product. You must accept these conditions and consider yourself fully responsible for the use of this product. If not, do not use this product.

Due to the continuous development of our products, the exact specifications of the kit may vary. If you have a problem with your new kit, please contact the store where you purchased it, indicating the part number(s).

Team Corally / JSP Group Intl bvba reserves the right to change any specification without notice. All rights reserved.

READ FIRST • QUICK START GUIDE

This owner's manual is designed for use with your vehicle and contains the instructions you will need to operate and maintain your vehicle.

- We know you want to start driving immediately after unpacking, but it is very important that you take the time to read this manual carefully, even if you are an experienced R/C driver.
- Read carefully and follow all instructions in this manual. Failure to comply with the instructions will be considered as abuse and/or negligence which may result in the cancellation of the warranty.
- Your vehicle is designed to operate on uneven terrain. However, dust, sand, water and carpet fibres can get into your car's work-spaces and can damage your vehicle if they are not removed quickly. We do not guarantee any warranty on your vehicle against damage caused by external elements such as sand, dirt or water. Users are responsible for the maintenance and safe operation of this vehicle.
- This product is not a toy. It is not suitable for users under 14 years of age, unless they are supervised by adults.
- Never attempt to disassemble electronic components. These have been carefully calibrated at the factory.
- Only improve your car with parts made for your car. If you upgrade performance, replace the entire system (such as the motor, inverter, battery, etc.) so that all components are properly adapted. Any malfunction resulting from a custom modification will void your warranty.
- Before driving your vehicle, please read this manual in its entirety and examine your vehicle and radio control system for any defects.
- For better performance, some adjustments may be necessary.
- This vehicle requires a battery (included in the car or in the packaging). Make sure the vehicle's battery is sufficiently charged before driving, otherwise you may lose control of the vehicle.
- The radio transmitter requires 4 AA batteries (not included)
- Always remove or disconnect the battery from the vehicle to the inverter when not in use.
- Please drive your car in a spacious place. Never drive your car on the street or in traffic. Public places are subject to specific legislation by country, city, municipality, please comply with the legislation for the use of RC models in your region.
- This product is fully assembled in the factory. We accept no liability for damage and/or accidents resulting from custom modifications and/or malfunctions.

SAFETY PRECAUTIONS • QUICK START GUIDE

For your safety, always use wear gloves and goggles when assembling and maintaining your model.

Always take all necessary precautions when handling products (silicone oil, grease, thread lock, cyanolyte glue, fuel) for the operation of the model. (Refer to the manufacturer's instructions)

For your safety, to keep the warranty and obtain the best performance, always use original CORALLY genuine parts.

Contains: LEAD (CAS 7439-92-1) ANTIMONY (CAS 7440-36-0)

WARNING: This product contains a chemical known to the state of California to cause cancer and birth defects or other reproductive harm.

CAUTION: CANCER HAZARD

Contains lead, a listed carcinogen. Lead is harmful if ingested. Wash thoroughly after using.

DO NOT use product while eating, drinking or smoking.

USE PRECAUTIONS • QUICK START GUIDE



Failure to operate your model in a safe and responsible manner may result in injury to yourself, others or damage to property around you.

- Do not use your model on public roads or in areas where you may encounter pedestrians or riders.
- Do not operate in a congested area or in crowds.
- Do not operate in areas where loud noises can disturb others, such as hospitals and residential areas.
- Do not operate your model with obstructed line of sight, at night or near water.
- Your model is radio controlled, it is subject to possible radio interference. Radio interference can cause loss of control of your model. Be careful.
- Take care not to injure yourself while using tools to adjust or upgrade your model.
- Since the model contains small parts, keep out of reach of children while assembling and/or disassembling your model.
- If your model becomes stuck against an object, release the throttle and retrieve it by hand
- Do not continue to apply the throttle when your model is stuck. This may damage the motor and/or ESC/ Receiver unit.
- Turn OFF your model and don't use it if it runs erratically. Please do not use your model again until the problem has been solved.
- Keep the wheels of the model off the ground when checking the operation of the radio equipment.
- When learning to operate your model, go to an area that has no obstacles that can damage your model.
- Before and after each use, check all the screws on the model.
- To maintain the best performance, check that all moving parts move freely.

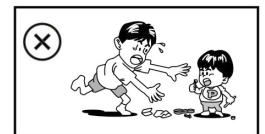
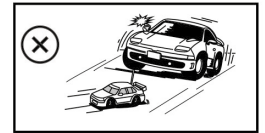

Take all necessary precautions before, during and after using your model. You are responsible for the safe assembly, maintenance and use of your model.

In case of any questions, contact your local reseller or contact Team Corally support for assistance.

LIPO BATTERY SAFETY PRECAUTIONS • QUICK START GUIDE

- Follow and respect the manufacturer's instructions for use
- It is important to check that your ESC is set to LIPO if you are using a LIPO battery. Failure to comply with this instruction will result in increased battery discharge and may cause fire and damage to persons and property.
- When charging or storing LiPo batteries always use LiPo Safety Bag (Flame retardant).
- Always respect the maximum rate and voltage specified by the battery manufacturer.
- Charge the LIPO battery outdoors or in a ventilated area away from flammable objects and surfaces.
- NEVER leave your LiPo battery unattended while charging.
- If the battery swells during charging, stop charging immediately and disconnect the battery from the charger. Leave the battery outside for a few hours and observe. Then recycle the battery according to the instructions of your country/region. Never dispose of a LIPO battery with domestic waste.
- Before recycling your defective battery, it must be neutralized. Take a plastic container, fill it with water and add a lot of salt until the water becomes opaque. Place the LIPO battery in the water and leave for 24 hours. Check with a voltmeter that the voltage is 0.0V. Then recycle the battery according to local regulations.
- Never charge a damaged or inflated battery.
- Never discharge the battery cells below 3.2V.
- Always use the appropriate balancer/charger when charging your LiPo battery pack.
- When the battery is empty, check the temperature of the battery before charging it. If the battery is very hot, wait until it cools before charging it.
- Never charge a very hot battery as this may cause an explosion or fire.
- When the battery is empty, recharge it immediately. Do not store an empty battery, the battery will continue to discharge, it will fall below the minimum voltage and become unusable.

WARRANTY • QUICK START GUIDE



If material defects or manufacturing faults should arise in a product distributed or manufactured by Team Corally / JSP Group Intl bvba, and purchased by a consumer, we Team Corally / JSP Group Intl bvba acknowledge the obligation to correct those faults or defects within the limitations described below. This manufacturer's warranty is in addition to, and does not affect, the legal or contractual rights of the consumer which arise from the purchase of such products. Team Corally / JSP Group Intl bvba guarantees the consumer that its products are free from material, manufacturing, and construction faults, as determined by the general state of knowledge and technology valid at the time of manufacturing. The fault responsible for causing the damage must be proven to have been present in the product at this time. Claims for compensation arising from consequential damage or product liability will not be considered valid unless they fall under peremptory provisions of the law. If material defects or manufacturing faults should arise in a product distributed or manufactured by Team Corally / JSP Group Intl bvba in the European community (EC) and purchased by a consumer, then Team Corally / JSP Group Intl bvba undertakes to correct those defects within the limitations described below. This manufacturer's declaration does not affect the consumer's legal or contractual rights regarding defects arising from the purchase contract between the consumer and the dealer or reseller. **Extend of the Warranty**

If a claim is made under warranty, we take at our discretion to repair or replace the defective goods. We will not consider supplementary claims, especially for reimbursement of costs relating to the defect (e.g. installation / removal costs) and compensation for consequent damages unless they are allowed by statute. This does not affect claims on legal regulations, especially according to the product liability law.

Provisions of the Warranty

The purchaser is required to make the warranty claim in writing, and must enclose original proof of purchase (e.g. invoice, receipt, delivery note) and the appropriate warranty card. He must send the defective goods to our local representatives or directly to Team Corally / JSP Group Intl bvba, Geelseweg 80, 2250 Olen, Belgium at his own risk and cost.

The purchaser should state the material defect or manufacturing fault, or symptoms of the fault, as accurate as possible, so that we can check if our warranty obligation is applicable. The goods are transported from the consumer to us, and from us to the consumer, entirely at the risk and cost of the consumer.

Invalidation of the Warranty

The consumer cannot make a claim under warranty when the fault is affecting the use of the product arising from natural wear, competition use, or improper use (including installation) or external forces. The consumer's adherence to the building and operating instructions relevant to the model, including the installation, operation, use of, and maintenance of, model-related components cannot be supervised by Team Corally / JSP Group Intl bvba. Therefore Team Corally / JSP Group Intl bvba is in no way liable for loss, damage, or costs resulting from improper use, or behaviour in any way connected to the above described provisions. Unless otherwise required by law, Team Corally / JSP Group Intl bvba is in no way whatever liable to provide compensation for damages arising from the improper use of the model (including personal injury, death, damage to buildings, loss of turnover, loss of business, or interruption of business, or any other direct, or indirectly caused, consequential damage).

Duration of Validity

The claim period is 24 months from the date of purchase of the product by the consumer from a dealer in the European Community (EC) counted from the date of purchase. The claim period is 12 months from the date of purchase of the product by the consumer from a dealer outside the European Community (EC) counted from the date of purchase. If a defect arises after the end of the claim period, or if evidence or documents required according to this declaration in order to make the claim valid are not presented until after this period, then the consumer forfeits any rights or claims from this declaration. The guarantee period is not prolonged by the granting of any claims within the framework of this warranty, especially in the case of repair or replacement. The guarantee period also does not restart in such cases.

Warranty Expiration

If we do not acknowledge the validity of a claim based on this declaration within the claim period, all claims based on this declaration will expire after six months from the time of registering the claim; however this cannot occur prior to the end of the claim period.

For any support, contact us at support.corally.com

DOWNLOAD • QUICK START GUIDE



Download the latest version of this manual and other languages.

Download updated PDF pages of : **Spare parts - Option Parts - Exploded Views - Screws Chart ...**

www.corally.com/Downloads/

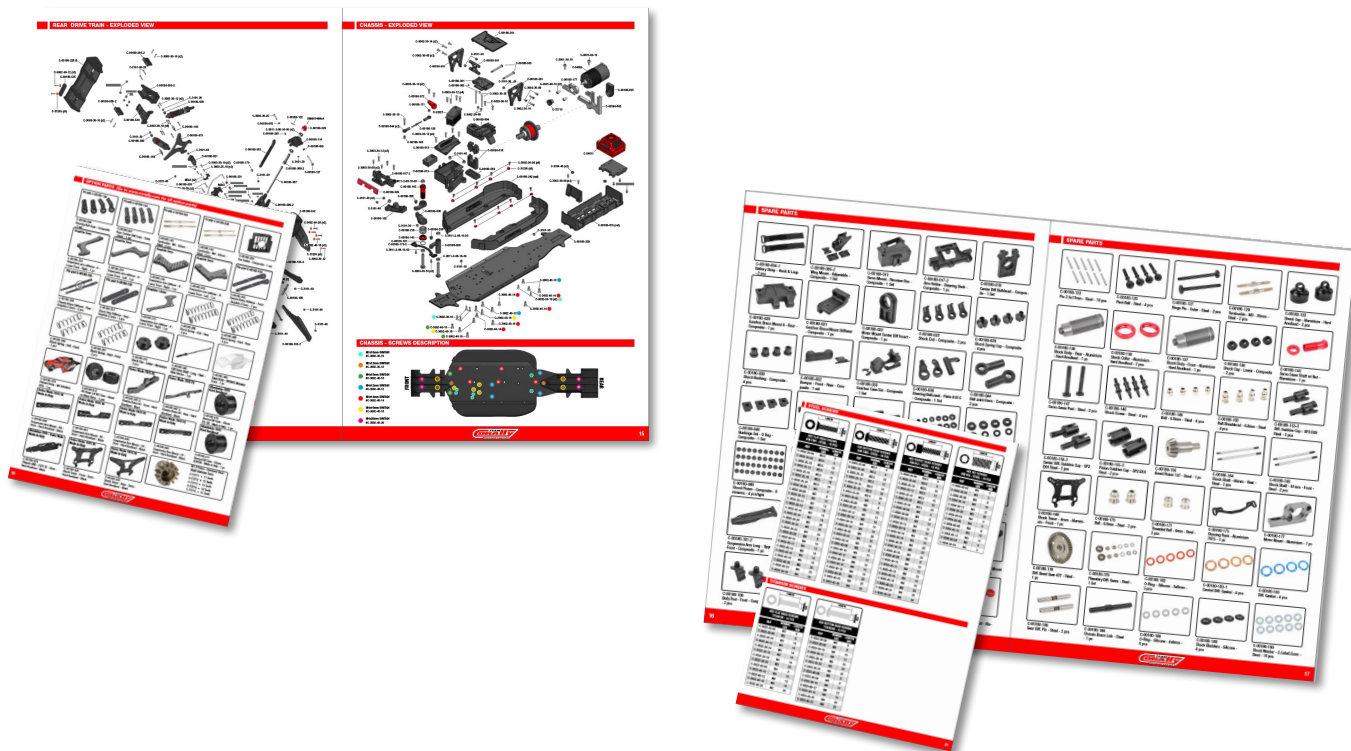

KIT CONTENT (Depends on the selected model)

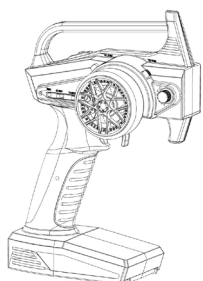

Transmitter

The model may be different in the box

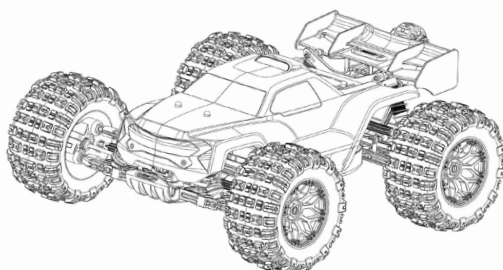

RTR Model



User Guide

REQUIRED FOR OPERATION (Not included)

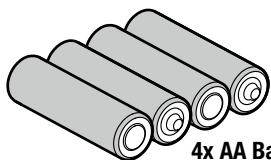

**4x AA Batteries
for the Transmitter**

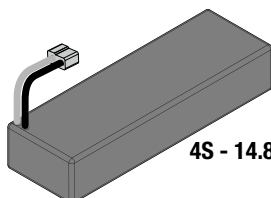

4S - 14.8V LiPo Battery

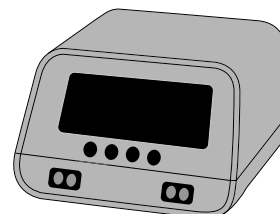

Charger

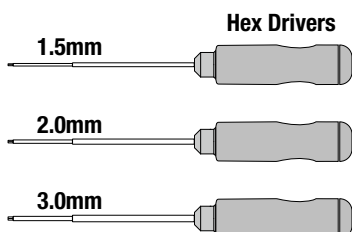

Hex Drivers

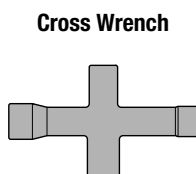

Cross Wrench



**Silicone Oil
(for maintenance)**

CAR COMPONENTS • QUICK START GUIDE

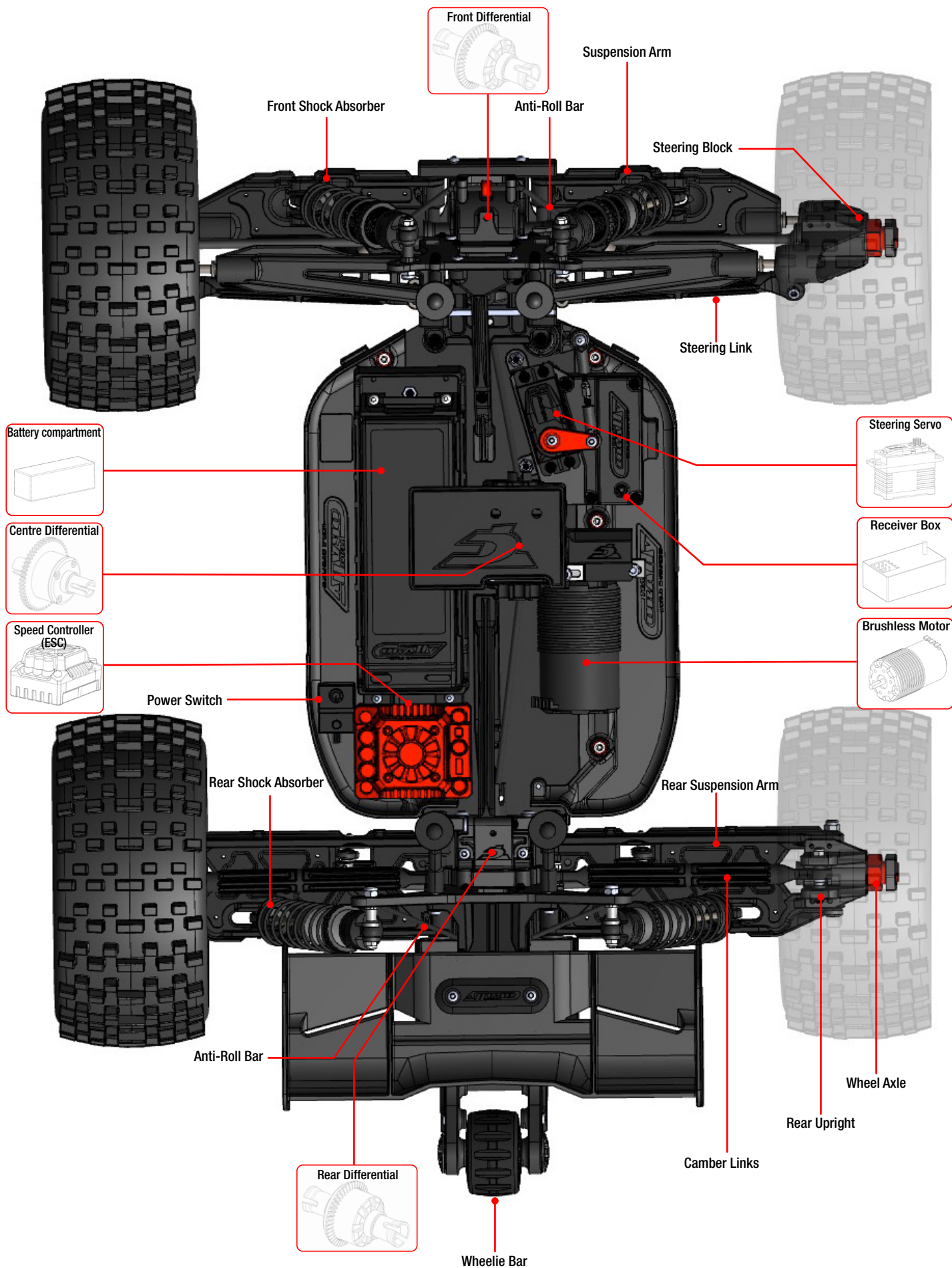

QUICK START GUIDE • QUICK START GUIDE



READ THE INSTRUCTIONS



CHARGE THE BATTERY

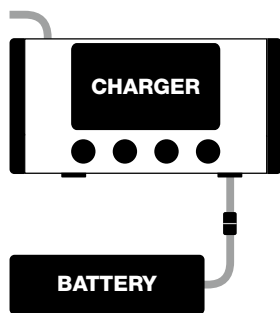

INSTALL 4x AA BATTERY

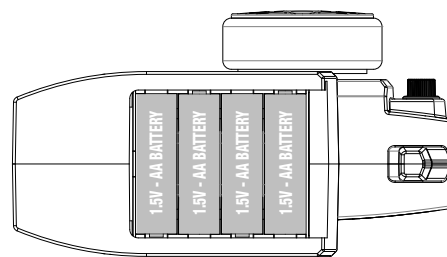

MAKE SURE THAT ALL SCREWS AND NUTS ARE TIGHTENED PROPERLY.

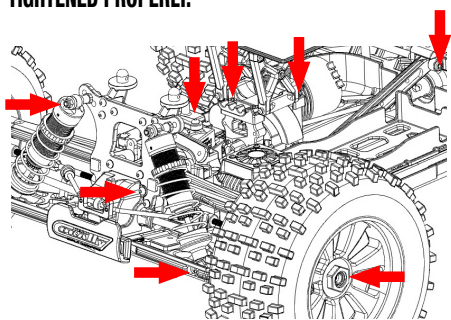

INSTALL THE BATTERY

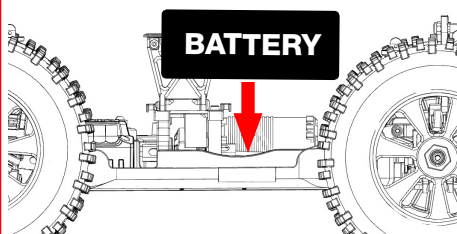

TURN ON THE TRANSMITTER (Always First)

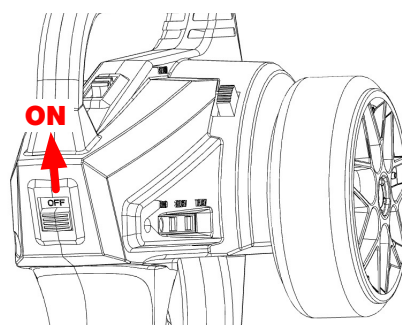

**1. CONNECT THE BATTERY TO THE ESC
2. SWITCH ON THE ESC**

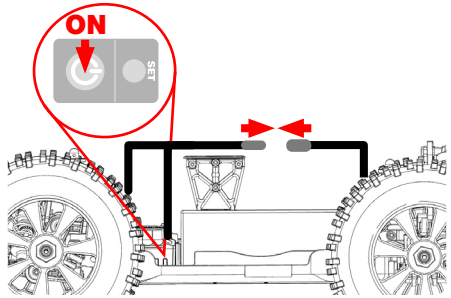

CHECK THE FUNCTIONS

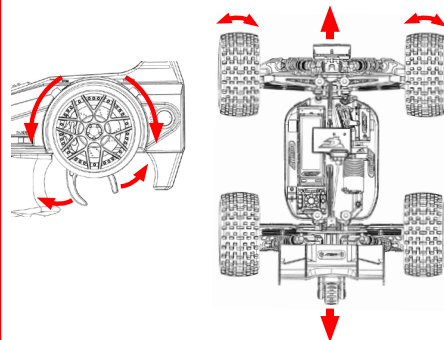

CHECK THE RADIO SYSTEM RANGE

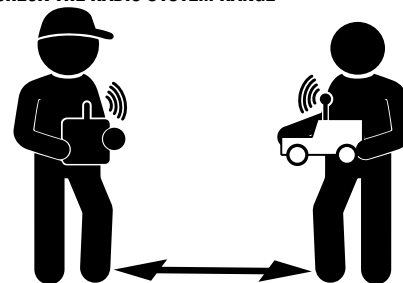

Move away from the max. distance you will drive the vehicle. Check that the vehicle responds properly to the controls. If not, reduce the distance or change the driving location.

DRIVE SLOWLY TO BEGIN

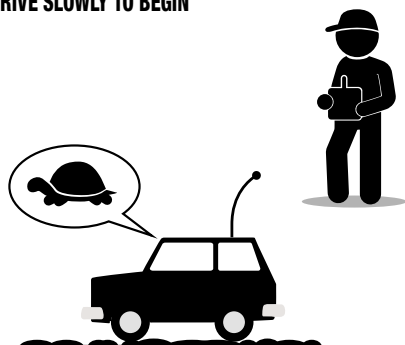

WHEN FINISHING

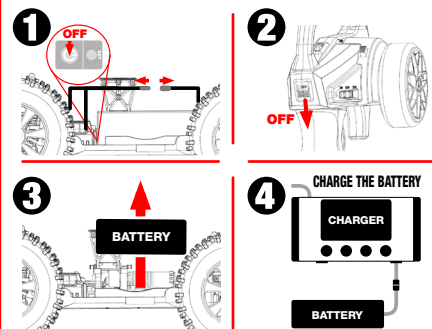

CLEAN AND MAINTAIN YOUR VEHICLE



MOTOR PINION MOD1.0 - PIGNON MOTEUR MOD1.0 - MOTORRITZEL MOD1.0 - MOTOR PINION MOD1.0



High-performance 13T tooth pinion gear, manufactured from special steel for toughness and durability with precise tolerances and assures unparalleled concentricity. Created on a special gear machine, all pinions feature ultra-precise tooth shaping and ultra-true running for vibration-free operation. Each pinion is marked with the tooth number for easy and quick identification.



Pignon 13 dents Haute Performance, fabriqué en acier spécial avec des tolérances précises pour garantir solidité, longévité et concentricité. Tous les pignons présentent une forme de dent ultra-précise pour un fonctionnement sans vibrations. Chaque pignon est marqué du nombre de dents pour une identification facile et rapide.



Hochleistungs-Ritzel mit 13 Zähnen, hergestellt aus Spezialstahl mit präzisen Toleranzen, um Festigkeit, Haltbarkeit und Rundlauf zu gewährleisten. Alle Ritzel haben eine ultrapräzise Zahnform für einen vibrationsfreien Betrieb. Jedes Kettenrad ist zur schnellen und einfachen Identifizierung mit der Anzahl der Zähne gekennzeichnet.



High-performance tandwiel 13-T, geproduceerd van speciaal staal met nauwkeurige toleranties om sterkte, duurzaamheid en concentriciteit te garanderen. Alle kettingwielen hebben een ultra-precieze tandvorm voor een trillingsvrije werking. Elk tandwiel is gemarkeerd met het aantal tanden voor een snelle en eenvoudige identificatie.

Special hardened steel

- Acier spécial trempé - Spezialgehärteter Stahl - Geharde speciaal staal

CNC cut teeth for perfect teeth shape and concentricity

- Usiné CNC pour une forme et une concentricité parfaites des dents
 - CNC-gefräst für perfekte Zahnform und Rundlaufgenauigkeit
 - CNC gefreesd voor perfecte tandvorm en concentriciteit

Module MOD1

Fits all cars with MOD1 gears (1/8 Scale)

- Convient à toutes les voitures avec des transmissions MOD1 (Echelle 1/8)
 - Passend für alle Fahrzeuge mit MOD1-Getriebe (Maßstab 1/8)
 - Past op alle auto's met MOD1 versnellingen (1/8 Schaal)

For 5.0mm motor shafts

- Pour les axes moteur de 5,0 mm
 - Für 5,0 mm Motorwellen
 - Voor 5,0mm motorassen

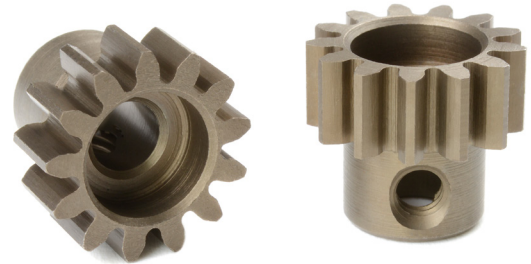

www.corally.com/Pinions-Gears/Pinions-MOD1/

SPEED GEAR CHART - TABLEAU DES VITESSES - DREHZAHLGANGDIAGRAMM - VERSNELLINGSTABEL

GEAR RATIO : 3.31

GEAR RATIO : 3.31	Km/h	Mph	Km/h	Mph	Km/h	Mph	Km/h	Mph	Km/h	Mph	Km/h	Mph
Gear	11T Pinion		12T Pinion		13T Pinion		14T Pinion		15T Pinion		16T Pinion	
50T	15,04		13,78		12,72		11,81		11,03		10,34	
4S	61	38	67	42	73	45	78	49	84	52	89	55
6S	92	57	100	62	109	68	117	73	126	78	134	83
52T	15,64		14,33		13,23		12,29		11,47		10,75	
4S	59	37	64	40	70	43	75	47	80	50	86	53
6S	89	55	97	60	105	65	113	70	121	75	129	80

■ OK
 ■ Factory fitted
 ■ Usable but not recommended
 ■ Not recommended, at your own risk



Note: The speed indicated in the table is a theoretical speed for information purposes. The real speed varies according to the type of terrain, electronic equipment, atmospheric conditions and other driving parameters.

Note: La vitesse indiquée dans le tableau est une vitesse théorique à titre indicatif. La vitesse réelle varie en fonction du type de terrain, de l'équipement électronique, des conditions atmosphériques et d'autres paramètres de conduite.

Bemerkung: Die in der Tabelle angegebene Geschwindigkeit ist eine theoretische Geschwindigkeit, die nur als Referenz dient. Die tatsächliche Geschwindigkeit hängt von der Art des Geländes, der elektronischen Ausrüstung, den Wetterbedingungen und anderen Fahrparametern ab.

Nota: De in de tabel aangegeven snelheid is een theoretische snelheid, uitsluitend ter referentie. De werkelijke snelheid varieert afhankelijk van het soort terrein, de elektronische apparatuur, de weersomstandigheden en andere rijparameters.



If the gear mesh is not correct, you wear out the spur gear prematurely, the transmission will make noise, give unnecessary load on the motor (higher consumption, heating of the transmission).



Si l'espace entre le pignon et la couronne n'est pas correct, la couronne dentée s'use prématurément, la transmission fait du bruit et le moteur est inutilement sollicité (consommation plus élevée, échauffement de la transmission).



Wenn der Abstand zwischen Ritzel und Tellerrad nicht stimmt, verschleißt das Zahnrad vorzeitig, das Getriebe macht Geräusche und der Motor wird unnötig belastet (höherer Verbrauch, Erwärmung des Getriebes).



Als de afstand tussen het tandwiel en de recht tandwiel niet correct is, slijt de recht tandwiel voortijdig, maakt de transmissie lawaai en wordt de motor onnodig belast (hoger verbruik, verhitting van de transmissie).

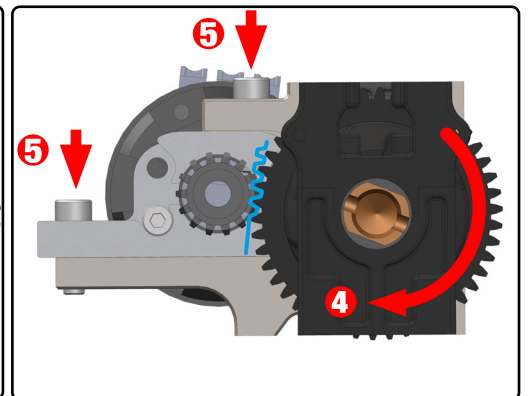
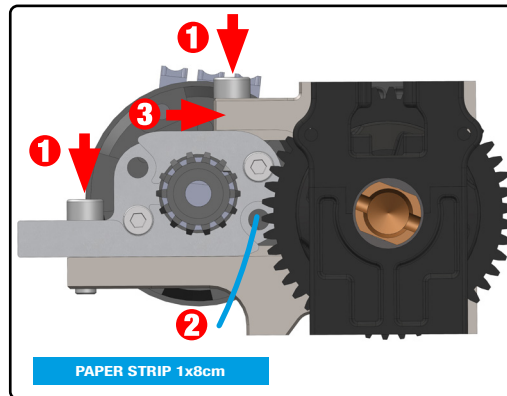
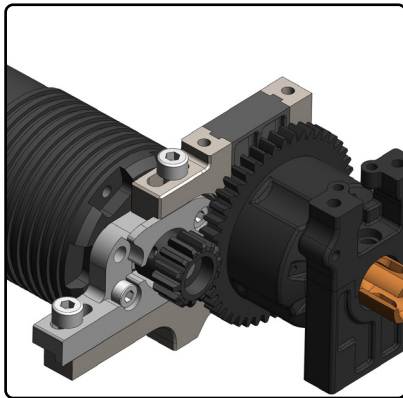

1. Loosen the screws.

Desserrez les vis.

Lösen Sie die Schrauben.

Draai de schroeven los.

2. Insert the paper strip.

Insérez la bande de papier.

Legen Sie den Papierstreifen ein.

Plaats de papierstrook.

3. Push the motor against the spur gear.

Poussez le moteur contre la couronne dentée.

Schieben Sie den Motor gegen das Zahnrad.

Duw de motor tegen het recht tandwiel.

4. Turn the spur gear to run the paper through the teeth.

Stop when the paper is in the middle.

Make sure that the motor pinion is against the spur gear.

Tournez la couronne dentée pour faire passer le papier entre les dents.

Arrêtez lorsque le papier est au milieu.

Assurez-vous que le pignon du moteur est contre la couronne dentée.

Drehen Sie das Hauptzahnrad, um das Papier durch die Zähne zu führen.

Halten Sie an, wenn sich das Papier in der Mitte befindet.

Achten Sie darauf, dass das Motorritzel am Hauptzahnrad anliegt.

Draai aan het rechte tandwiel om het papier door de tanden te laten lopen.

Stop wanneer het papier in het midden is.

Zorg ervoor dat het motortandwiel tegen het rechte tandwiel staat.

5. Maintain and tighten the fixing screws.

Maintenez et serrez les vis de fixation.

Halten Sie die Befestigungsschrauben fest und ziehen Sie sie an.

De bevestigingsschroeven aanhouden en vast-draaien.

It may be necessary to replace the silicone oil in the shock absorbers every 40 runs (depends on how you drive and the type of terrain you drive on).

Il peut être nécessaire de remplacer l'huile silicone des amortisseurs toutes les 40 courses (cela dépend de votre conduite et du type de terrain sur lequel vous roulez).

Es kann notwendig sein, das Silikonöl in den Stoßdämpfern alle 40 Fahrten zu wechseln (abhängig von Ihrer Fahrweise und dem Gelände, auf dem Sie fahren).

Het kan nodig zijn de siliconenolie in de schokdempers om de 40 ritten te vervangen (afhankelijk van uw rijstijl en het soort terrein waarop u rijdt).

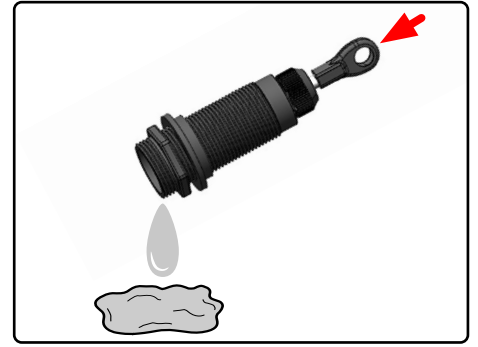
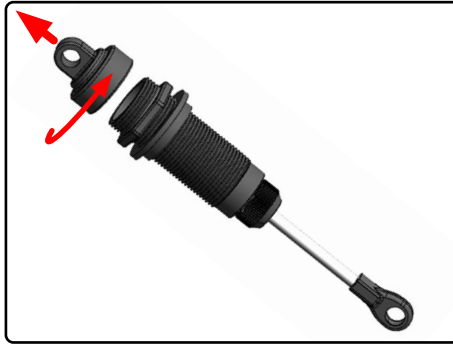
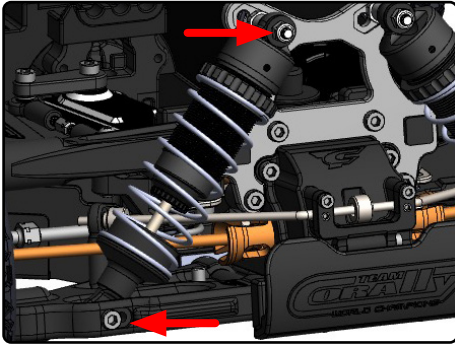

ALWAYS USE SILICONE OIL, NEVER USE ANY OTHER TYPES OF OIL.

	FILL	MOVE UP	WAIT 5min	TIGHTEN 50%	MOVE UP	TIGHTEN FULLY
1	2	3-4x	5min	50%	SLOWLY	
	• Fill the shock with silicone oil.	• Move the piston up&down (3-4x) to release the air bubbles in the silicone oil.	• Pull the Shock shaft down and wait until the bubbles rise to the surface.	• Screw in the shock absorber cap at 50%.	• Gently move the piston in upper position, the oil excess will flow out.	• Now tighten the cap fully but not too much otherwise the membrane will be deformed.
	• Remplissez l'amortisseur avec de l'huile de silicone.	• Déplacez le piston de haut en bas (3-4x) pour libérer les bulles d'air.	• Tirez la tige d'amortisseur vers le bas et attendez que les bulles remontent à la surface.	• Vissez le bouchon d'amortisseur à 50%	• Déplacez doucement le piston en position haute, l'excédent d'huile s'écoulera.	• Maintenant, serrez le bouchon à fond, mais pas trop, sinon la membrane sera déformée.
	• Füllen Sie den Dämpfer mit Silikonöl.	• Bewegen Sie den Kolben nach oben&unten (3-4x), um die Luftblasen abzulassen.	• Ziehen Sie die Schockwelle nach unten und warten Sie, bis die Blasen an die Oberfläche steigen.	• Schrauben Sie die Stoßdämpferkappe zu 50 % ein.	• Bewegen Sie den Kolben vorsichtig in die obere Position, das überschüssige Öl fließt dann heraus.	• Ziehen Sie nun die Kappe vollständig, aber nicht zu fest an, da sonst die Membran verformt wird.
	• Vul de schokdemper met siliconenolie.	• Beweeg de zuiger op en neer (3-4x) om de luchtbel-len te laten ontsnappen.	• Trek de Schokas naar beneden en wacht tot de luchtballen naar de oppervlakte stijgen.	• Schroef de dop van de schokdemper op 50%.	• Beweeg de piston langzaam in de bovenste positie, de overtollige olie zal eruit stromen.	• Draai nu de dop helemaal vast, maar niet te vast, anders wordt het membraan vervormd.

	FRONT		REAR		SHOCK PISTON
	SILICONE OIL	SPRING TENSION	SILICONE OIL	SPRING TENSION	
TRACK USE	450CPS	4mm	400CPS	0mm	6 Holes Ø1.3mm
OFF-ROAD	600CPS	4mm	500CPS	0mm	6 Holes Ø1.3mm
BASHING	650CPS	4mm	550CPS	0mm	6 Holes Ø1.3mm
FACTORY	600CPS		500CPS		6 Holes Ø1.3mm

- **Do not overtighten the Shock Cap to prevent deformation of the silicone Shock Bladder.**
- *Ne serrez pas trop le capuchon de l'amortisseur pour éviter la déformation de la membrane en silicone.*
- Ziehen Sie die Dämpferabdeckung nicht zu fest an, um eine Verformung der Silikonmembran zu vermeiden.
- *Draai de schokkap niet te strak aan om vervorming van het siliconenmembraan te voorkomen.*

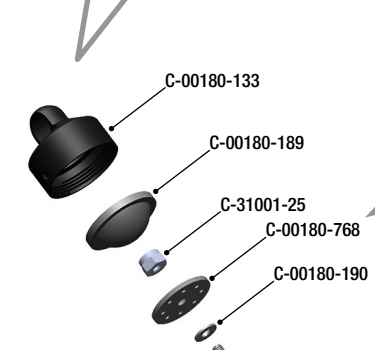

C-00180-768 Shock Piston



Set content (8PCS)

- Shock Piston - **6 Holes**
- Shock Piston - **8 Holes**

C-00180-166
(Front - Avant - Vorne - Voor)
C-00180-164
(Rear - Arrière - Ninten - Achter)

C-00180-137
(Front - Avant - Vorne - Voor)
C-00180-134
(Rear - Arrière - Ninten - Achter)



Place all small parts on a screwdriver (Ø3mm) and push them into the shock body. All parts will be properly aligned.

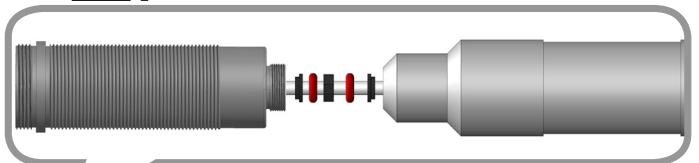

- *Placez toutes les petites pièces sur un tournevis (Ø3mm) et poussez-les dans le corps de l'amortisseur. Toutes les pièces seront correctement alignées.*
- *Setzen Sie alle Kleinteile auf einen Schraubendreher (Ø3mm) und drücken Sie sie in den Dämpferkörper. Alle Teile werden richtig ausgerichtet.*
- *Plaats alle kleine onderdelen op een schroevendraaier (Ø3mm) en duw ze in de behuizing van de schokdemper. Alle onderdelen zullen goed uitgelijnd zijn.*

APPLY SILICONE OIL

- Appliquez de l'huile silicone
- Silikonöl auftragen
- Breng siliconenolie aan

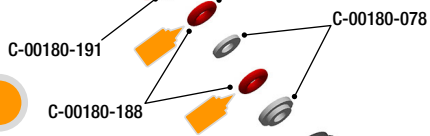

C-00180-138

C-00180-192

C-00180-136

C-00180-290 (Front - Avant - Vorne - Voor)
C-00180-287 (Rear - Arrière - Ninten - Achter)

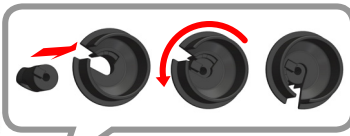

C-00180-029

C-00180-769 (Long)

C-00180-149

C-00180-770 (Short)

It may be necessary to replace the silicone oil every 50 runs (depends on how you drive and the type of terrain you drive on).

Il peut être nécessaire de remplacer l'huile silicone toutes les 50 courses (cela dépend de votre conduite et du type de terrain sur lequel vous roulez).

Es kann notwendig sein, das Silikonöl alle 50 Fahrten zu wechseln (abhängig von Ihrer Fahrweise und dem Gelände, auf dem Sie fahren).

Het kan nodig zijn de siliconenolie om de 50 ritten te vervangen (afhankelijk van uw rijstijl en het soort terrein waarop u rijdt).

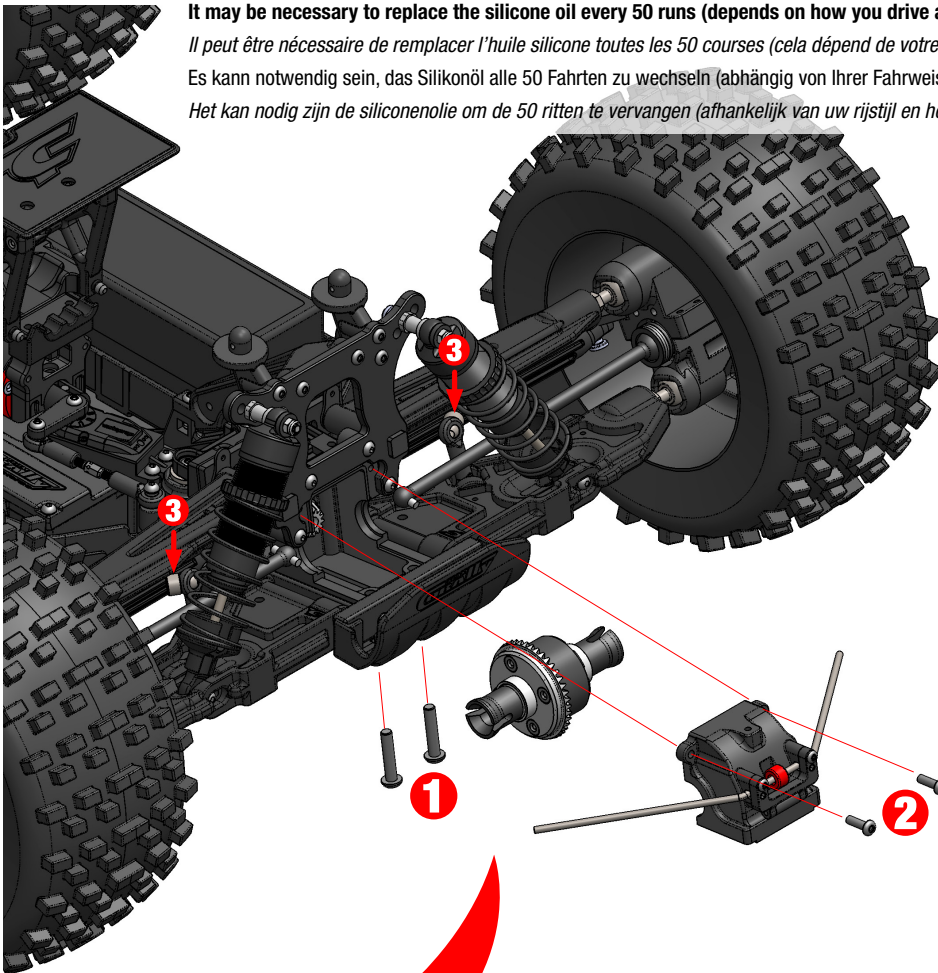

- **1. Remove 2 screws under the chassis.**
Retirez 2 vis sous le châssis.
Entfernen Sie 2 Schrauben unter dem Chassis.
Verwijder 2 schroeven onder het chassis.
- **2. Remove the screws from the differential cover.**
Retirez les vis du couvercle du différentiel.
Entfernen Sie die Schrauben des Differentialdeckels.
Verwijder de schroeven van het deksel van het differentieel.
- **3. Unscrew the ANTI-ROLL BAR Screws.**
Dévissez les vis de la barre anti-roulis.
Lösen Sie die ANTI-ROLL BAR-Schrauben.
Schroef de ANTI-ROLL BAR-schroeven los.
- **4. Unscrew the differential. (4x F/H M3x10)**
Ouvrir le différentiel.
Öffnen Sie das Differential.
Open het differentieel.
- **5 Drain the silicone oil from the differential.**
Vidangez l'huile de silicone du différentiel.
Lassen Sie das Silikonöl aus dem Differential ab.
Laat de siliconenolie uit het differentieel lopen.
- **6 Fill with new silicone oil (75% capacity max.)**
Remplir avec de l'huile silicone neuve (75% max.)
Füllen Sie neues Silikonöl ein (max. 75% Füllmenge).
Vullen met nieuwe siliconenolie (75% capaciteit max.)



Perform the same maintenance operation for the Centre and Rear differentials.

Effectuez la même opération d'entretien pour les différentiels central et arrière.

Führen Sie die gleichen Wartungsarbeiten für das mittlere und hintere Differential durch.

Doe dezelfde onderhoudswerkzaamheden voor het midden- en achterdifferentieel.



	FRONT DIFF	CENTRE DIFF	REAR DIFF
TRACK USE	7500CPS	15.000CPS	5000CPS
OFF-ROAD	10.000CPS	30.000CPS	7500CPS
BASHING	20.000CPS	100.000CPS	10.000CPS
FACTORY	20.000CPS	100.000CPS	10.000CPS

www.corally.com/Chemicals/Silicone-Oils/

It may be necessary to replace the silicone oil every 50 runs (depends on how you drive and the type of terrain you drive on).

Il peut être nécessaire de remplacer l'huile silicone toutes les 50 courses (cela dépend de votre conduite et du type de terrain sur lequel vous roulez).

Es kann notwendig sein, das Silikonöl alle 50 Fahrten zu wechseln (abhängig von Ihrer Fahrweise und dem Gelände, auf dem Sie fahren).

Het kan nodig zijn de siliconenolie om de 50 ritten te vervangen (afhankelijk van uw rijstijl en het soort terrein waarop u rijdt).

- Remove 4 screws.

Retirez les 4 vis.

Entfernen Sie 4 Schrauben.

Verwijder 4 schroeven.

- Release the Centre Diff Plate Cover.

Déposez le couvercle de la plaque du différentiel central.

Lösen Sie die Abdeckung der mittleren Differentialplatte.

Maak het middendifferentieelplaatdeksel los.

- Extract the differential and follow the maintenance instruction on the DIFFERENTIAL MAINTENANCE section.

Extraire le différentiel et suivre les instructions d'entretien de la section ENTRETIEN DU DIFFERENTIEL.

Bauen Sie das Differenzial aus und befolgen Sie die Wartungsanweisungen im Abschnitt WARTUNG DES DIFFERENZIALS.

Verwijder het differentieel en volg de onderhoudsinstructies in het hoofdstuk ONDERHOUD DIFFERENTIEEL.

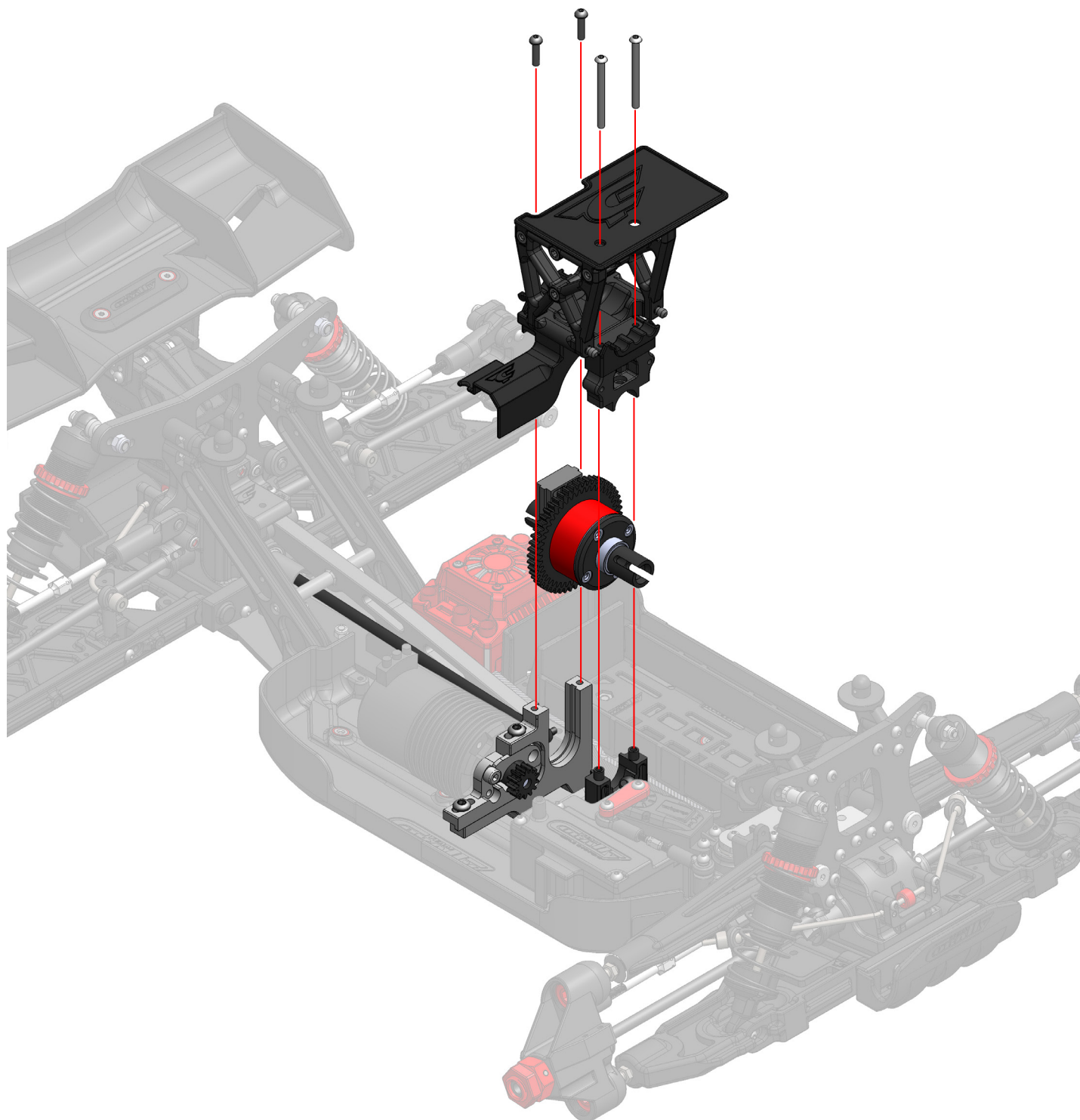

FRONT & REAR DIFFERENTIAL - DIFFÉRENTIEL AVANT ET ARRIÈRE - DIFFERENTIAL VORNE UND HINTEN - VOOR & ACHTER DIFFERENTIEEL

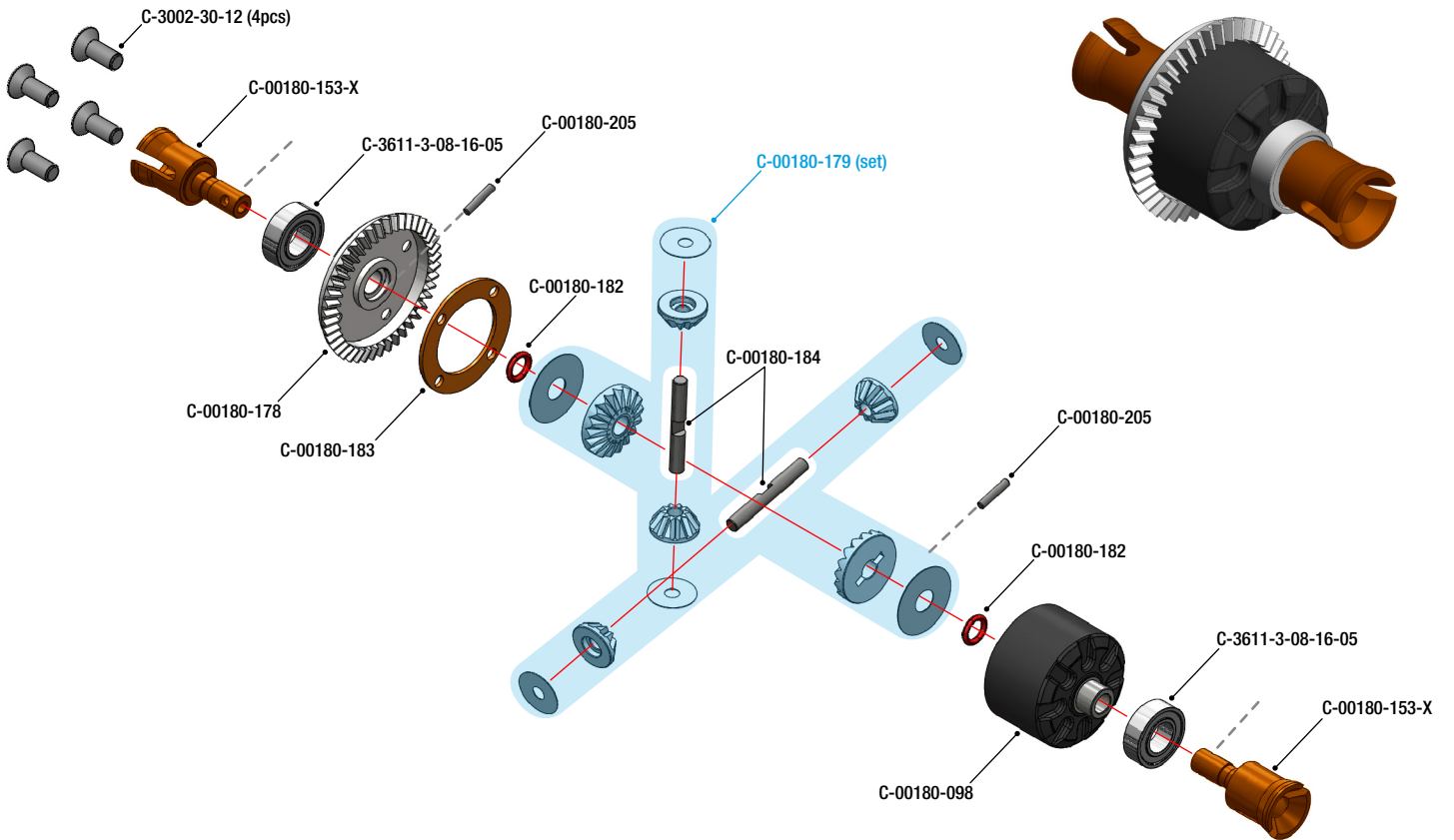

CENTRE DIFFERENTIAL - DIFFÉRENTIEL CENTRAL - ZENTRALDIFFERENTIAL - CENTERDIFFERENTIEEL

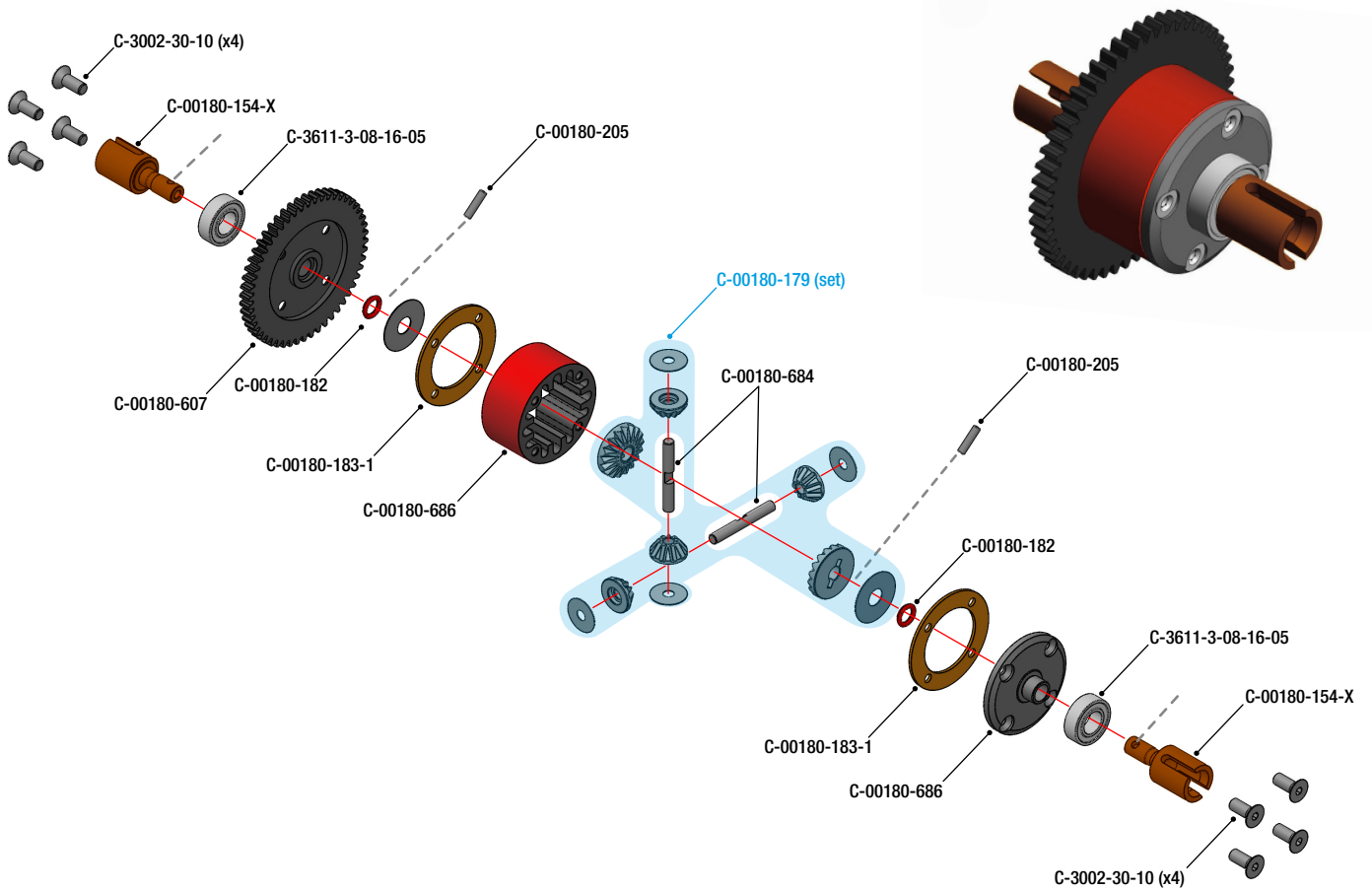

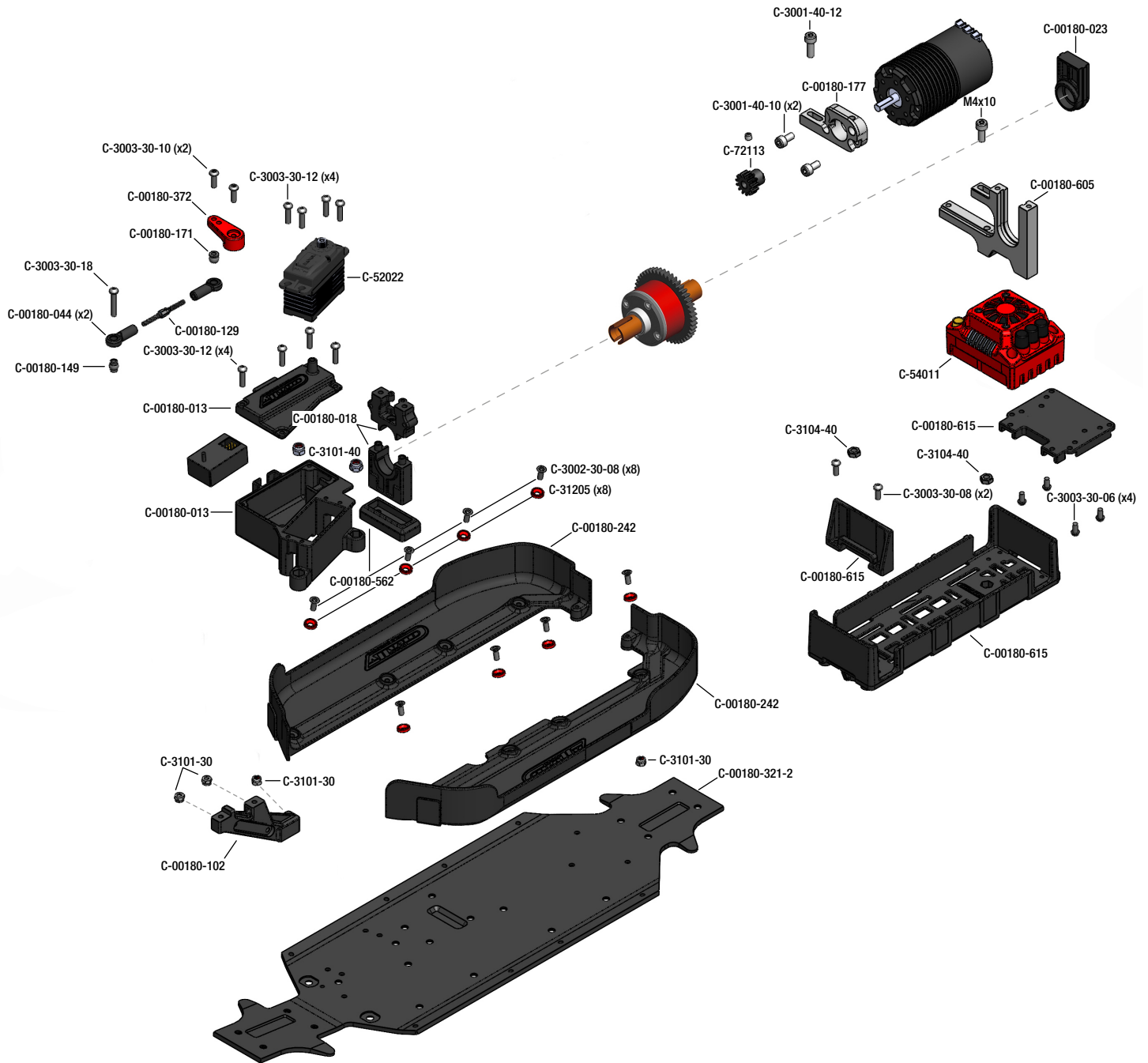

CHASSIS - SCREWS DESCRIPTION - DESCRIPTION DES VIS - BESCHREIBUNG DER SCHRAUBEN - BESCHRIJVING SCHROEVEN

- M3x10mm DIN7991
#C-3002-30-10
- M3x12mm DIN7991
#C-3002-30-12
- M4x10mm DIN7991
#C-3002-40-10
- M4x12mm DIN7991
#C-3002-40-12
- M4x14mm DIN7991
#C-3002-40-14
- M4x16mm DIN7991
#C-3002-40-16
- M4x20mm DIN7991
#C-3002-40-20

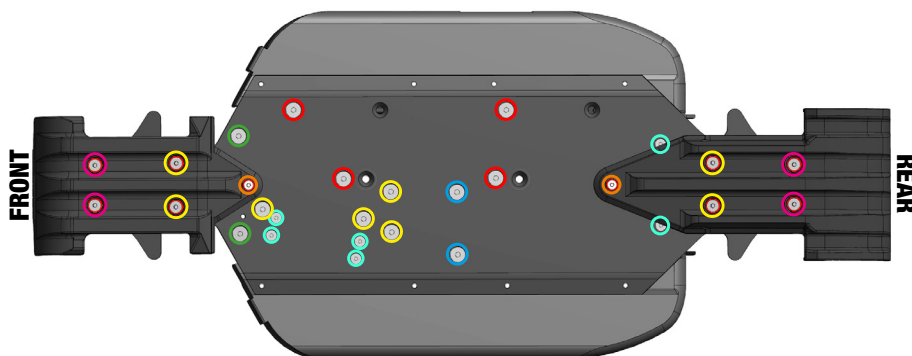

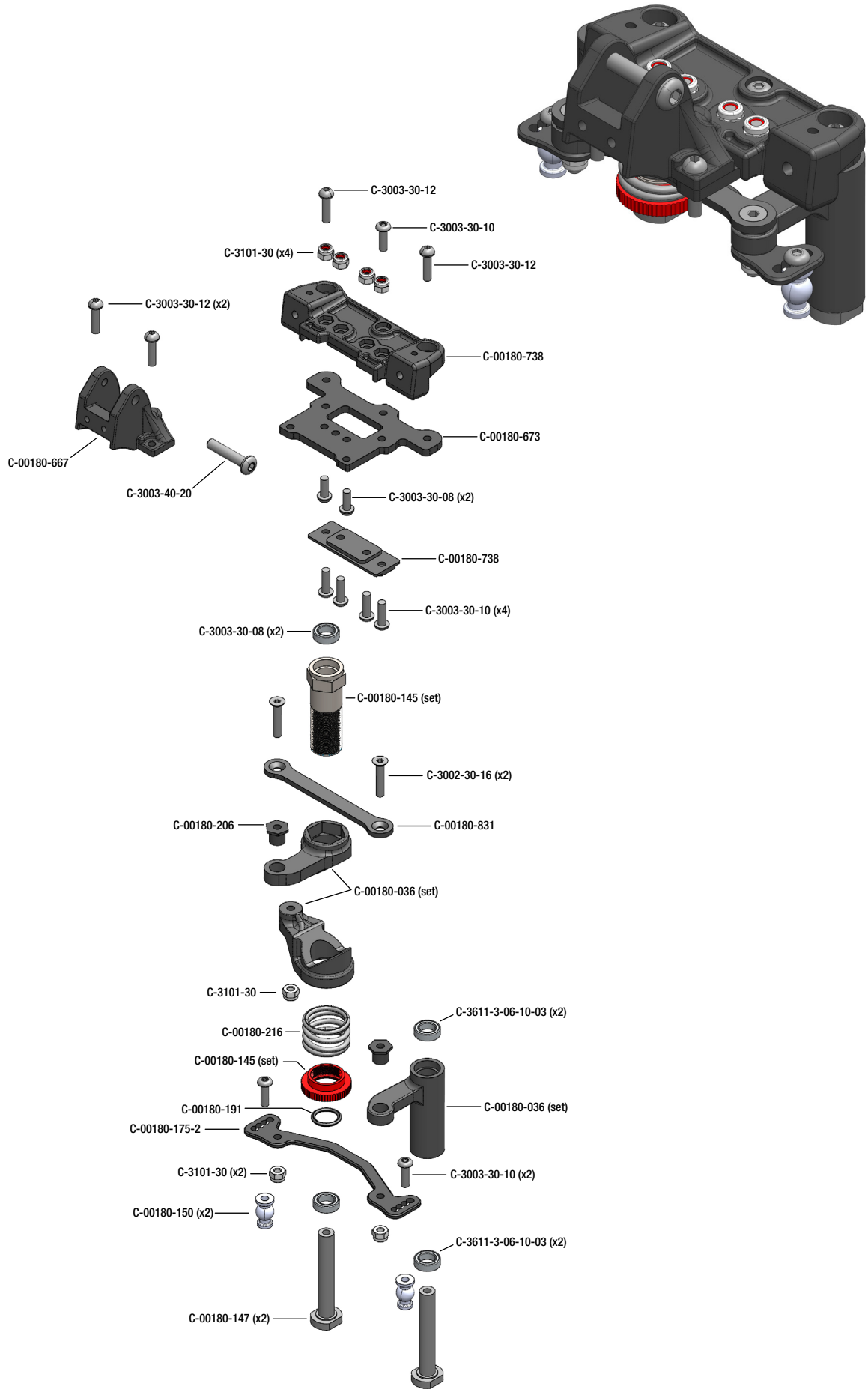





C-00180-004-1
Battery Strap - Hook & Loop
- 2 pcs



C-00180-005-2
Wing Mount - Adjustable -
Composite - 1 Set



C-00180-013
Servo Mount - Receiver Box -
Composite - 1 Set



C-00180-016-2
Chassis Brace - Rear - Com-
posite - 1 pc



C-00180-018
Centre Diff Bulkhead - Compos-
ite - 1 Set



C-00180-023
Motor Mount Centre Diff Insert -
Composite - 1 pc



C-00180-030
Shock Bushing - Composite -
4 pcs

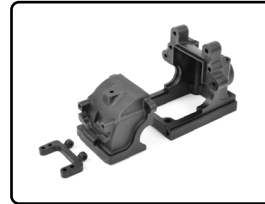

C-00180-033
Gearbox Case Set - Composite
- 1 Set



C-00180-036
Steering Bellcrank - Parts A-B-C
- Composite - 1 set



C-00180-044
Ball Joint 6mm - Composite -
2 pcs

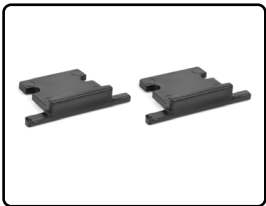

C-00180-045
Bumper Spacer- Front - Rear -
Composite - 1 pcs

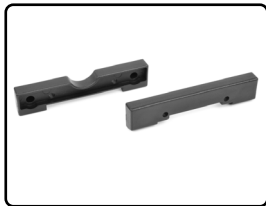

C-00180-051
Suspension Arm Mount - Front -
Composite - 1 Set

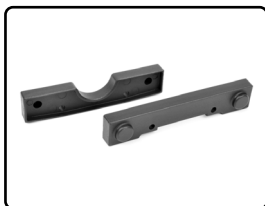

C-00180-052
Suspension Arm Mount - Rear -
Composite - 1 Set

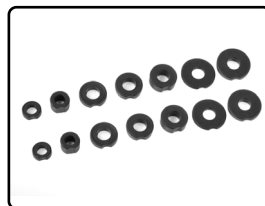

C-00180-055
Suspension Arm Shim - Com-
posite - 1 Set

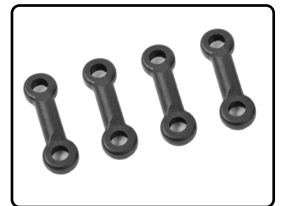

C-00180-089
Anti-Roll Bar Ball Cups - Com-
posite - 4 pcs



C-00180-099-2
Suspension Arm Long - V2 -
Lower - Rear - Composite - 1 pc



C-00180-100-2
Suspension Arm Long - V2 -
Lower - Front - Composite - 1 pc



C-00180-101-2
Suspension Arm Long - V2 - Up-
per - Front - Composite - 1 pc



C-00180-102
Chassis Brace - Front - Com-
posite - 1 pc



C-00180-106
Body Post - Front - Composite
- 2 pcs



C-00180-107
Body Post - Rear - Composite
- 2 pcs



C-00180-108-1
HD Steering Block Wide - Pivot
Ball Cup (2) - Composite - 1 set

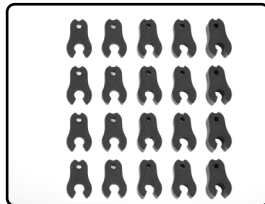

C-00180-109
Caster Clips Set - 1 to 4.5mm
- 1 Set



C-00180-114
Rear Upright - MT - Composite
- 1 pc

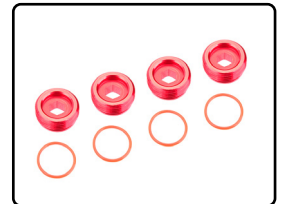

C-00180-117-1
Pivot Ball Adjusting Nut - Alu-
minium - 4 pcs

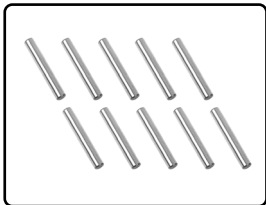

C-00180-122
Pin 2.5x17mm - Steel - 10 pcs



C-00180-123
Pivot Ball - Steel - 4 pcs



C-00180-127
Hinge Pin - Outer - Steel - 2 pcs



C-00180-129
Turnbuckle - M3 - 35mm -
Steel - 2 pcs



C-00180-145
Servo Saver Shaft w/ Nut -
Aluminium - 1 pc



C-00180-147
Servo Saver Post - Steel - 2 pcs



C-00180-148
Shock Screw - Steel - 4 pcs



C-00180-149
Ball - 5.8mm - Steel - 4 pcs



C-00180-150
Ball Shouldered - 6.8mm - Steel
- 4 pcs



C-00180-170
Ball - 6.8mm - Steel - 2 pcs



C-00180-171
Threaded Ball - 6mm - Steel -
2 pcs



C-00180-175-2
Steering Rack - V2 - Aluminium
7075 - 1 pc

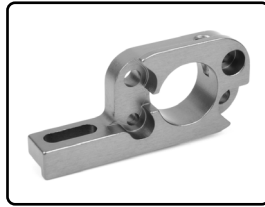

C-00180-177
Motor Mount - Aluminium - 1 pc

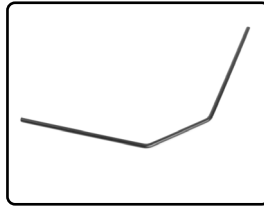

C-00180-197
Anti-Roll Bar - 2.4mm - Front
- 1 pc



C-00180-206
Steering Rack Bushing - Steel
- 2 pcs

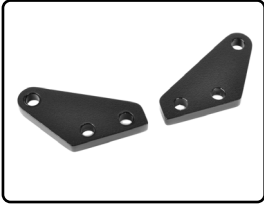

C-00180-207
Steering Block Arms - Alumi-
ni-um - 2 pcs



C-00180-216
Servo Saver Spring - 1 pc



C-00180-220
Ball End 5.8mm - for Anti Roll
Bar - Steel - 4 pcs



C-00180-226-B
Wing - Composite - 1 pc

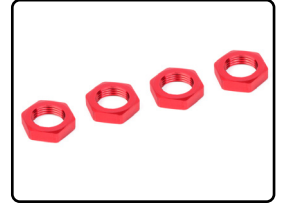

C-00180-230
Wheel Nut - Aluminium - 4 pcs



C-00180-231
Collar - for Anti-roll Bar - Alu-
minium - 1 pc

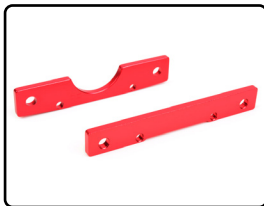

C-00180-238
Suspension Arm Mount - Rear -
Aluminium - 1 set

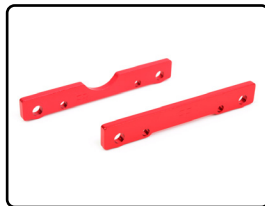

C-00180-240
Suspension Arm Mount - Front -
Aluminium - 1 Set



C-00180-242
Side Guards - Left-Right - Com-
posite - 1 Set



C-00180-246
Anti-Roll Bar - 2.6mm - Rear
- 1 pc

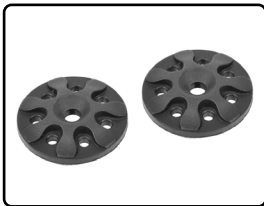

C-00180-251
Washer - Composite. -
2 pcs



C-00180-293
Ball 6.8mm - Steel - 4 pcs



C-00180-296
Wheelie Bar Mount - Left-Right
- Composite - 1 set



C-00180-300
Wheelie Bar Spacer - Compos-
ite - 1 pc

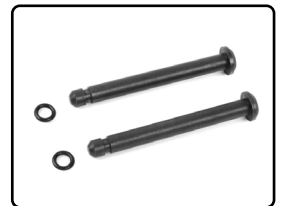

C-00180-305
Centre Roll Cage Pin - Steel -
2 pcs

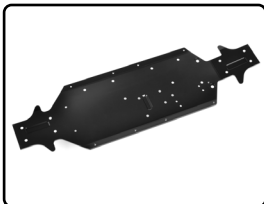

C-00180-321-2
Chassis - Buggy XP RTR - V2 -
Aluminium - 1 pc

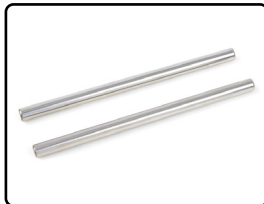

C-00180-322
Suspension Arm Pivot Pin - Low-
er Inner - Fr/Re - Steel - 2 pcs



C-00180-329
Wheel Hex Adapter - Wide RTR
- Aluminium - 2 pcs



C-00180-341
CVD Drive Shaft - Long - Front -
Wide Blocks - 1 pc



C-00180-367
Dogbones - Long - Rear - Steel
- 2 pcs



C-00180-368-X
PRO Drive Axle - Long - Rear -
Swiss Spring Steel - 2 pcs



C-00180-372
Servo Arm - Steering - Alu -
1 pc



C-00180-535
Wing Washer - Large - Com-
posite - 1 Pc



C-00180-539
Wing Mount Connecting Brace -
Composite - 1 Pc



C-00180-545
Axle - Single Wheel Wheelie Bar
- Steel - 1 Pc



C-00180-612
Off-Road 1/8 MT Tires - Glued
on Black Rims - 1 pair



C-00180-700
Polycarbonate Body - JAMBO
XP 6S - Painted - Cut - 1 pc

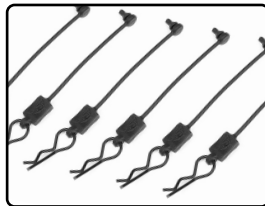

C-00180-614
Body Clip Retainer w/ Body clip
- Black - 6 pcs



C-00180-546
Wheelie Bar Wheel - Compos-
ite - 1 pc



C-00180-551
Front Bumper - Composite. -
1 pc



C-00180-552
Rear Bumper - Composite. - 1 pc



C-00180-553
Camber Links - Monster Truck - Composite - 2 pcs



C-00180-554
Steering Links - Monster Truck - Composite - 2 pcs



C-00180-562
Centre Diff Support Spacer - 4mm - Composite - 1 pc



C-00180-605
Motor Bulkhead - V2 - Aluminium - 1 pc



C-00180-615
Battery Tray - Large - Composite - 1 Pc



C-00180-616
Wheelie Bar Plate - Composite - 2 pcs



C-00180-640
Centre Diff Plate - for Chassis Tube - Composite - 1 pc



C-00180-655
Spur Gear Cover - Composite - 1 pc



C-00180-660
Switch Holder TOROX 185-135 - Composite - 1 set

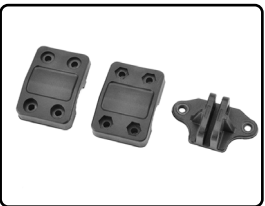

C-00180-662
Shock tower Brace Holder - Tube 12mm - Composite - 1 pc

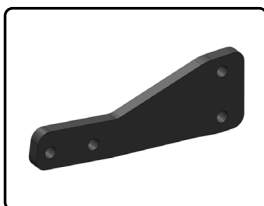

C-00180-663
Shock tower Brace - Front Aluminium - 1 pc



C-00180-667
Steering Deck Holder - Tube 12mm - Composite - 1 pc



C-00180-673
Steering Deck - XTR - Aluminium - Black - 1 Pc

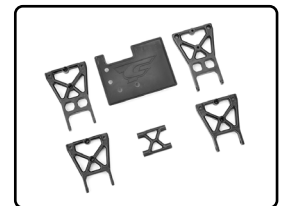

C-00180-716
Centre Roll Cage Mount - Composite - 1 Set



C-00180-719
Chassis Tube - 106mm - Aluminium - 1 set



C-00180-732
Chassis Tube - 135mm - Aluminium - 1 set



C-00180-738
Arm Holder for Steering Deck - Composite - 1 Pc



C-00180-765
Gear Box Brace Mount Stiffener - for Chassis Tube - Composite - 1 pc

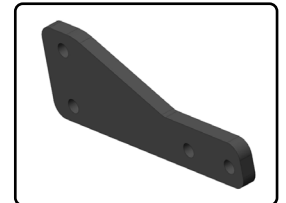

C-00180-815
Shock tower Brace - Front Aluminium - 1 pc



C-00180-817
Shock Tower - 5mm - Aluminium - Front - 1 pc

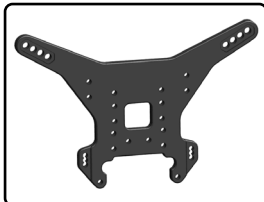

C-00180-820
Shock Tower - 5mm - Aluminium - Rear - 1 pc



C-00180-831
Steering Rack - Dual Stiffener - Aluminium - 1 Pc



C-00180-834
Centre Roll Cage Foam - Thickness 25mm - 1 pc



C-54055
Electric Motor - Kuron 825 - 4-Pole - 2050 KV - Brushless - Sensorless



C-72713
M1.0 Pinion - Hardened Steel - 13 Teeth - Shaft Dia. 5mm



C-52022
Digital Servo - CRHV-7225-MG - High Voltage - Core Motor - Metal Gear - 25 Kg Torque



C-54011
Speed Controller - TOROX 185 - Brushless - 2-6S

FRONT & REAR DIFFERENTIAL - SPARE PARTS

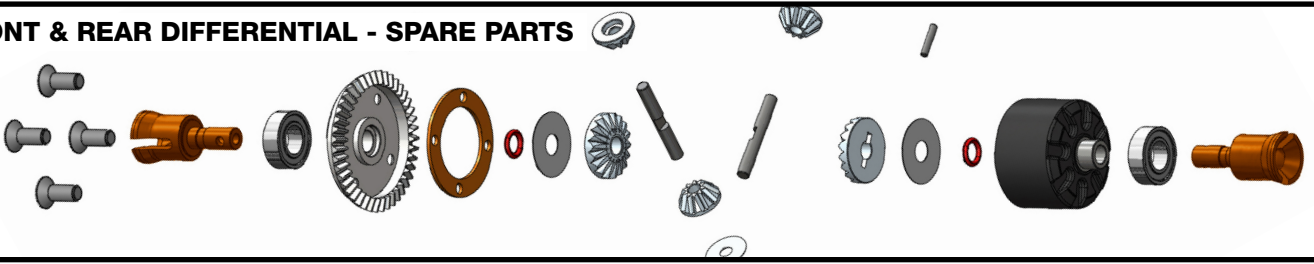

C-00180-687
Diff Assembly - Front / Rear -
43T Bevel Gear - 1 set



C-00180-090-1
Center Diff set - Case + diff
internals - 1 set



C-00180-178
Diff. Bevel Gear 43T - Steel -
1 pc

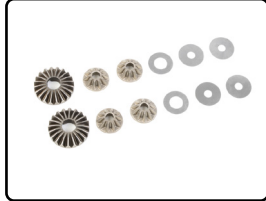

C-00180-179
Planetary Diff. Gears - Steel -
1 Set



C-00180-184
Gear Diff. Pin - Steel - 2 pcs

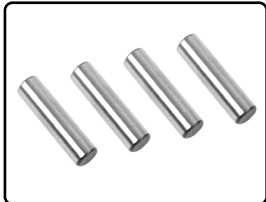

C-00180-205
Diff. Outdrive Pin - 2x11,8mm -
Steel - 4 pcs



C-00180-098
Diff Case - FR-RE - Composite
- 1 pc

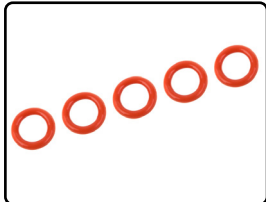

C-00180-182
O-Ring - Silicone - 5x8mm -
5 pcs

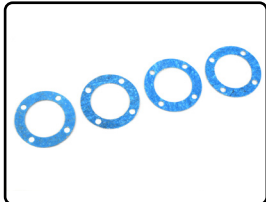

C-00180-183
Diff. Gasket - 4 pcs



C-00180-156
Bevel Pinion 13T - Steel - 1 pc



C-00180-153-X
PRO Diff. Outdrive Cup - Swiss
Spring Steel - 2 pcs



C-00180-155-X
PRO Pinion Outdrive Cup -
Swiss Spring Steel - 2 pcs

CENTRE DIFFERENTIAL - SPARE PARTS



C-00180-685-1
Centre Diff Assembly - Alu /
Steel - 52T Main Gear - 1 set



C-00180-686
Diff Case - Centre - Aluminium.
- 1 pc



C-00180-607
Spur Gear 52T - Steel - 1 pc

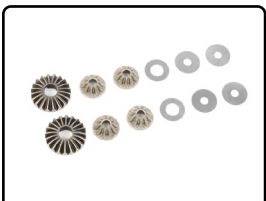

C-00180-179
Planetary Diff. Gears - Steel -
1 Set



C-00180-684
Gear Diff Pin - 3.5x29.8mm -
for C-00180-686 - Steel - 4 pcs



C-00180-183-1
Central Diff. Gasket - 4 pcs

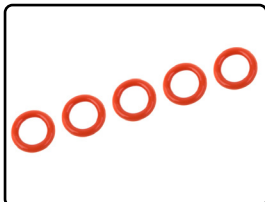

C-00180-182
O-Ring - Silicone - 5x8mm -
5 pcs



C-00180-154-X
PRO Centre Diff. Outdrive Cup -
Swiss Spring Steel - 2 pcs

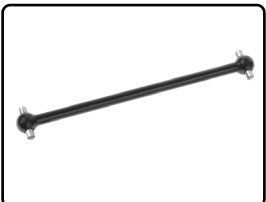

C-00180-715
Drive Shaft - Center - Front -
85.5mm - Steel - 1 pc

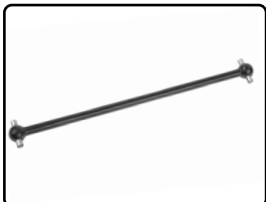

C-00180-714
Drive Shaft - Center - Rear -
110mm - Steel - 1 pc

SHOCK ABSORBER - SPARE PARTS



C-00180-133
Shock Cap - Aluminium - Hard Anodised - 2 pcs

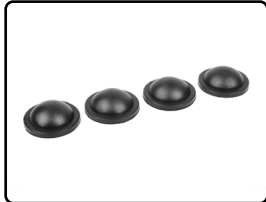

C-00180-189
Shock Bladders - Silicone - 4 pcs

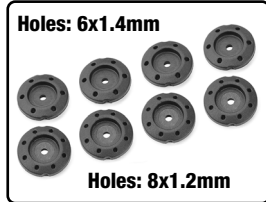

Holes: 6x1.4mm
C-00180-768
Shock Piston Heavy Duty - 4mm thick - 1 Set
Holes: 8x1.2mm

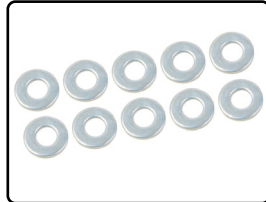

C-00180-190
Shock Washer - 2.5x6x0.5mm - Steel - 10 pcs

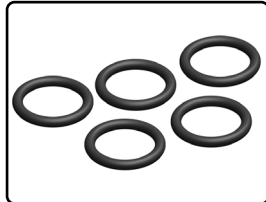

C-00180-191
O-Ring - Silicone - 9x12mm - 5 pcs



C-00180-164
Shock Shaft - 66mm - Rear - Steel - 2 pcs



C-00180-166
Shock Shaft - 61mm - Front - Steel - 2 pcs



C-00180-134
Shock Body - Rear - Aluminium - Hard Anodised - 1 pc



C-00180-137
Shock Body - Front - Aluminium - Hard Anodised - 1 pc



C-00180-136
Shock Collar - Aluminium - Hard Anodised - 2 pcs

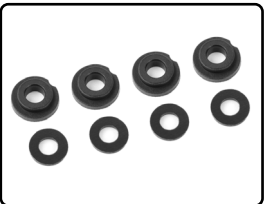

C-00180-078
Shock Body Insert - Washer - Composite - 1 set



C-00180-188
O-Ring - Silicone - 4x8mm - 5 pcs



C-00180-138
Shock Cap - Lower - Composite - 2 pcs

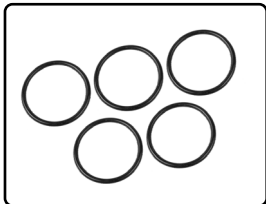

C-00180-192
O-Ring - Silicone - 16.2x19.8mm - 5 pcs

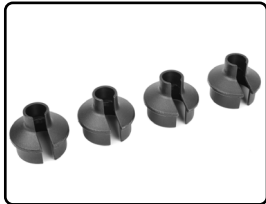

C-00180-029
Shock Spring Cup - Composite - 4 pcs

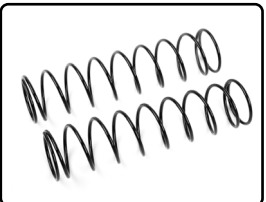

C-00180-287
Shock Spring - Medium - Rear - 2 pcs

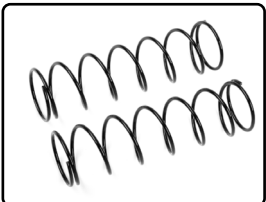

C-00180-290
Shock Spring - Medium - Front - 2 pcs

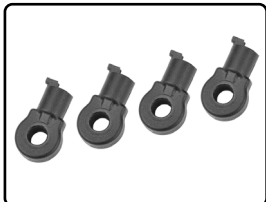

C-00180-770
HD Shock End - Short - Composite - 4 pcs

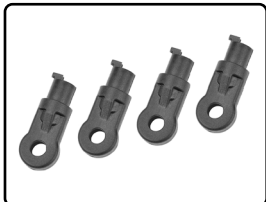

C-00180-769
HD Shock End - Long - Composite - 4 pcs



Fit with C-00180-144-2

C-00180-039
Steering Ball Cups - Composite
- 1 set



Fit with C-00180-143-2

C-00180-041
Rear Camber Ball Cups - Outer
- Inner - 1 set



Fit with C-00180-041

C-00180-143-2
Turnbuckle - M5 - 92mm -
Steel - 2 pcs



Fit with C-00180-039

C-00180-144-2
Turnbuckle - M4 - 92mm -
Steel - 2 pcs

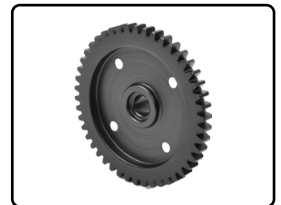

C-00180-606
Spur Gear 50T - CNC Machined
- Steel - 1 Pc



C-00180-224
Fan Holder for Fan 40 mm -
Composite - 1 set



C-00180-821
Blower fan Shroud - Diameter
42mm



C-00180-157
Wing Washer - Lightened -
Aluminum - 2 pcs



C-00180-316
Shock Cap - Lower - Aluminium
- 2 pcs



C-00180-378
Off-Road 1/8 MT Tires - Gripper
- Glued on Black Rims - 1 pair

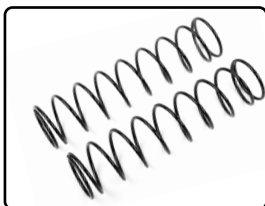

C-00180-286
Shock Spring - Soft - Rear
- 2 pcs

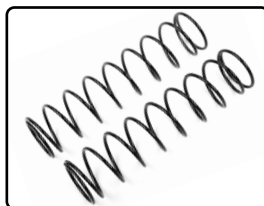

C-00180-288
Shock Spring - Hard - Rear
- 2 pcs



C-00180-289
Shock Spring - Soft - Front
- 2 pcs

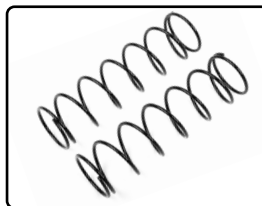

C-00180-291
Shock Spring - Hard - Front
- 2 pcs



C-00180-346
CVD Drive Shaft - Long - Rear -
Wide Hub - 1 pc

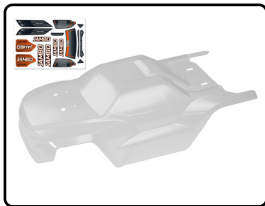

C-00180-701
Polycarbonate Body - JAMBO
XP 6S - Clear - Cut - 1 pc



C-00180-382
Polycarbonate Body - Dementor
XP 6S - Clear - Cut - 1 pc



C-00180-381
Polycarbonate Body - Dementor
XP 6S - Painted - Cut - 1 pc



C-00180-381-2
Polycarbonate Body - Dementor
XP 6S - Painted - Cut - 1 pc

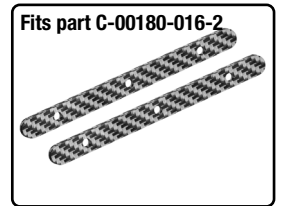

Fits part C-00180-016-2

C-00180-253
Chassis Brace Stiffener - Rear -
Graphite 2.5mm - 2 pcs



**Aluminium 7075
Hard Anodised**

C-00180-410
Xtreme Diff Case - 30mm -
FR / RE - Made in Italy - 1 pc



**Aluminium 7075
Hard Anodised**

C-00180-411
Xtreme Diff Case - 35mm -
CENTRE - Made in Italy - 1 pc



**Aluminium 7075
Hard Anodised**

C-00180-043
Chassis SWB - Swiss Made 7075
T6 - 3mm - Hard Anodised - Black

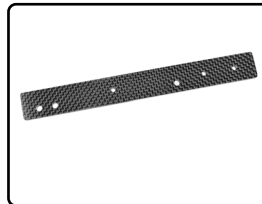

C-00180-677
Chassis Stiffener Sheet - XTR -
Rear - Graphite 3mm - 1 Pc



Swiss Made 7075 T6

C-00180-387-2
Chassis Brace V2 - Front - Hard
Anodised - Black

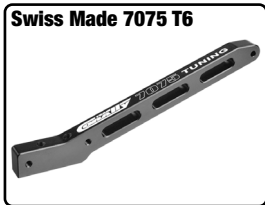

Swiss Made 7075 T6

C-00180-396-2
Chassis Brace V2 - Rear - Hard
Anodised - Black



**Swiss Made 7075 T6
Made in Italy**

C-00180-680
Suspension Arm Mount - RR -
3mm - Hard Anodised - Black



**Swiss Made 7075 T6
Made in Italy**

C-00180-681
Suspension Arm Mount - RF -
3mm - Hard Anodised - Black



**Swiss Made 7075 T6
Made in Italy**

C-00180-682
Suspension Arm Mount - FR -
3mm - Hard Anodised - Black



**Swiss Made 7075 T6
Made in Italy**

C-00180-683
Suspension Arm Mount - FF -
3mm - Hard Anodised - Black



**Swiss Made 7075 T6
Made in Italy**

C-00180-420
Shock Tower - Front - 5mm -
Hard Anodised - Black



**Swiss Made 7075 T6
Made in Italy**

C-00180-421
Shock Tower - Rear - 5mm -
Hard Anodised - Black



C-49145-X
Sport Racing 50C - 5400Mah - 4S
- 14,8V - XT-90 - Hard Case



C-49146-X
Sport Racing 60C - 6700Mah - 4S
- 14,8V - XT-90 - Hard Case



C-49164-X
Sport Racing 150C - 4500Mah - 6S
- 22,2V - XT-90 - Hard Case



C-52001
High Speed Servo - High Voltage
- Coreless Motor - Titanium Gear



C-52015
OC-27 HV Digital Servo - 5-8.4V -
IP-67 - Core DC Motor - Steel Gear

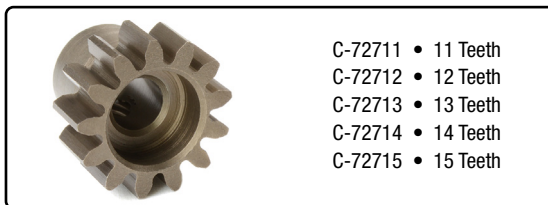

- C-72711 • 11 Teeth
- C-72712 • 12 Teeth
- C-72713 • 13 Teeth
- C-72714 • 14 Teeth
- C-72715 • 15 Teeth

M1.0 Pinion - Hardened Steel - Shaft Diameter 5mm



Check the availability of option parts on the website www.corally.com

Visualisez la disponibilité des pièces d'option sur le site web www.corally.com

Sehen Sie sich die Verfügbarkeit von Optionteilen auf der Website www.corally.com an.

Controleer de beschikbaarheid van optieonderdelen op de website www.corally.com

STEEL SCREWS - VISSERIE ACIER • STAHSCHRAUBEN • STAAL SCHROEVEN

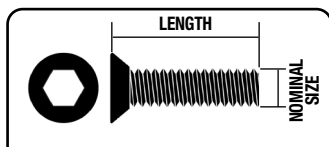

**HEX FLAT HEAD SCREWS
DIN 7991 - STEEL - 10 PCS**

REF	NOMINAL SIZE	LENGTH MM
C-3002-25-06	M2.5	6
C-3002-25-08	M2.5	8
C-3002-25-10	M2.5	10
C-3002-25-12	M2.5	12
C-3002-25-16	M2.5	16
C-3002-25-18	M2.5	18
C-3002-25-20	M2.5	20
C-3002-30-06	M3	6
C-3002-30-08	M3	8
C-3002-30-10	M3	10
C-3002-30-12	M3	12
C-3002-30-14	M3	14
C-3002-30-16	M3	16
C-3002-30-18	M3	18
C-3002-30-20	M3	20
C-3002-30-25	M3	25
C-3002-30-35	M3	35
C-3002-40-08	M4	8
C-3002-40-10	M4	10
C-3002-40-12	M4	12
C-3002-40-14	M4	14
C-3002-40-16	M4	16
C-3002-40-18	M4	18
C-3002-40-20	M4	20
C-3002-40-25	M4	25
C-3002-40-30	M4	30

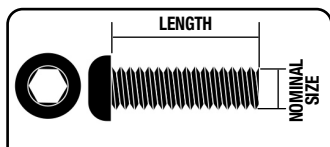

**HEX BUTTON HEAD SCREWS
DIN 7380 - STEEL - 10 PCS**

REF	NOMINAL SIZE	LENGTH MM
C-3003-25-06	M2.5	6
C-3003-25-08	M2.5	8
C-3003-25-10	M2.5	10
C-3003-25-12	M2.5	12
C-3003-25-16	M2.5	16
C-3003-25-18	M2.5	18
C-3003-25-20	M2.5	20
C-3003-30-06	M3	6
C-3003-30-08	M3	8
C-3003-30-10	M3	10
C-3003-30-12	M3	12
C-3003-30-14	M3	14
C-3003-30-16	M3	16
C-3003-30-18	M3	18
C-3003-30-20	M3	20
C-3003-30-25	M3	25
C-3003-30-35	M3	35
C-3003-40-08	M4	8
C-3003-40-10	M4	10
C-3003-40-12	M4	12
C-3003-40-14	M4	14
C-3003-40-16	M4	16
C-3003-40-18	M4	18
C-3003-40-20	M4	20
C-3003-40-25	M4	25
C-3003-40-30	M4	30

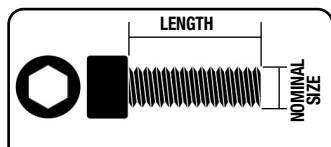

**HEX SOCKET HEAD SCREWS
DIN 912 - STEEL - 10 PCS**

REF	NOMINAL SIZE	LENGTH MM
C-3000-25-06	M2.5	6
C-3000-25-08	M2.5	8
C-3000-25-10	M2.5	10
C-3000-25-12	M2.5	12
C-3000-25-16	M2.5	16
C-3000-25-18	M2.5	18
C-3000-25-20	M2.5	20
C-3000-30-06	M3	6
C-3000-30-08	M3	8
C-3000-30-10	M3	10
C-3000-30-12	M3	12
C-3000-30-14	M3	14
C-3000-30-16	M3	16
C-3000-30-18	M3	18
C-3000-30-20	M3	20
C-3000-30-25	M3	25
C-3000-30-35	M3	35
C-3000-40-08	M4	8
C-3000-40-10	M4	10
C-3000-40-12	M4	12
C-3000-40-14	M4	14
C-3000-40-16	M4	16
C-3000-40-18	M4	18
C-3000-40-20	M4	20
C-3000-40-25	M4	25
C-3000-40-30	M4	30

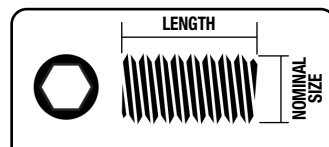

**HEX SET SCREWS
DIN 916 - STEEL - 10 PCS**

REF	NOMINAL SIZE	LENGTH MM
C-3004-30-03	M3	3
C-3004-30-05	M3	5
C-3004-30-08	M3	8
C-3004-30-10	M3	10
C-3004-30-12	M3	12
C-3004-30-20	M3	20
C-3004-40-04	M4	4
C-3004-40-06	M4	6
C-3004-40-08	M4	8
C-3004-40-10	M4	10
C-3004-40-12	M4	12
C-3004-50-04	M5	4
C-3004-50-05	M5	5

TITANIUM SCREWS - VISSERIE TITANE • TITANIUMSCHRAUBEN • TITANIUM SCHROEVEN

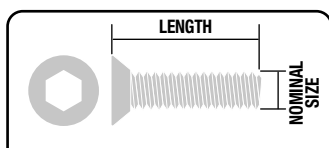

**HEX FLAT HEAD SCREWS
TITANIUM - 10 PCS**

REF	NOMINAL SIZE	LENGTH MM
C-3022-30-06	M3	6
C-3022-30-08	M3	8
C-3022-30-10	M3	10
C-3022-30-12	M3	12
C-3022-30-14	M3	14
C-3022-30-16	M3	16
C-3022-30-18	M3	18
C-3022-30-20	M3	20
C-3022-40-08	M4	8
C-3022-40-10	M4	10
C-3022-40-12	M4	12
C-3022-40-16	M4	16
C-3002-40-20	M4	20

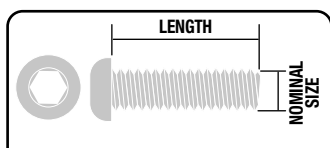

**HEX BUTTON HEAD SCREWS
TITANIUM - 10 PCS**

REF	NOMINAL SIZE	LENGTH MM
C-3023-30-06	M3	6
C-3023-30-08	M3	8
C-3023-30-10	M3	10
C-3023-30-12	M3	12
C-3023-30-16	M3	16
C-3023-30-20	M3	20
C-3023-30-25	M3	25
C-3023-40-06	M4	6
C-3023-40-08	M4	8
C-3023-40-10	M4	10
C-3023-40-12	M4	12
C-3023-40-16	M4	16
C-3023-40-20	M4	20
C-3023-40-25	M4	25

NUTS - ECROUS • MUTTERN • MOEREN

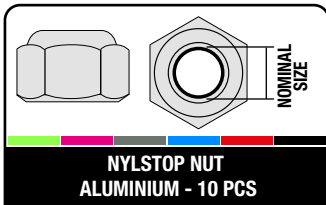

NYLSTOP NUT
ALUMINIUM - 10 PCS

REF	NOMINAL SIZE	COLOR
C-3106-20-0	M2	Gold
C-3106-20-1	M2	Green
C-3106-20-2	M2	Purple
C-3106-20-3	M2	Gun
C-3106-20-4	M2	Blue
C-3106-20-5	M2	Red
C-3106-20-6	M2	Black
C-3106-30-0	M3	Gold
C-3106-30-1	M3	Green
C-3106-30-2	M3	Purple
C-3106-30-3	M3	Gun
C-3106-30-4	M3	Blue
C-3106-30-5	M3	Red
C-3106-30-6	M3	Black
C-3106-40-0	M4	Gold
C-3106-40-1	M4	Green
C-3106-40-2	M4	Purple
C-3106-40-3	M4	Gun
C-3106-40-4	M4	Blue
C-3106-40-5	M4	Red
C-3106-40-6	M4	Black
C-3106-50-0	M5	Gold
C-3106-50-1	M5	Green
C-3106-50-2	M5	Purple
C-3106-50-3	M5	Gun
C-3106-50-4	M5	Blue
C-3106-50-5	M5	Red
C-3106-50-6	M5	Black

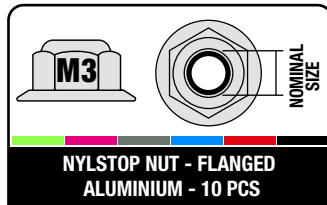

NYLSTOP NUT - FLANGED
ALUMINIUM - 10 PCS

REF	NOMINAL SIZE	COLOR
C-3107-30-0	M3	Gold
C-3107-30-1	M3	Green
C-3107-30-2	M3	Purple
C-3107-30-3	M3	Gun
C-3107-30-4	M3	Blue
C-3107-30-5	M3	Red
C-3107-30-6	M3	Black
C-3107-40-0	M4	Gold
C-3107-40-1	M4	Green
C-3107-40-2	M4	Purple
C-3107-40-3	M4	Gun
C-3107-40-4	M4	Blue
C-3107-40-5	M4	Red
C-3107-40-6	M4	Black
C-3107-50-0	M5	Gold
C-3107-50-1	M5	Green
C-3107-50-2	M5	Purple
C-3107-50-3	M5	Gun
C-3107-50-4	M5	Blue
C-3107-50-5	M5	Red
C-3107-50-6	M5	Black

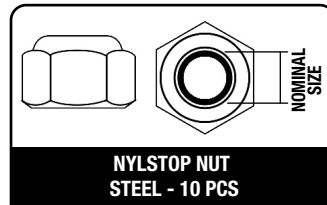

NYLSTOP NUT
STEEL - 10 PCS

REF	NOMINAL SIZE	COLOR
C-3101-20-6	M2	Black
C-3101-25	M2.5	Silver
C-3101-25-6	M2.5	Black
C-3101-30	M3	Silver
C-3101-30-6	M3	Black
C-3101-40	M4	Silver
C-3101-40-6	M4	Black

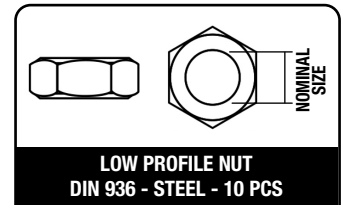

LOW PROFILE NUT
DIN 936 - STEEL - 10 PCS

REF	NOMINAL SIZE	COLOR
C-3104-40	M4	Silver
C-3104-50	M5	Silver

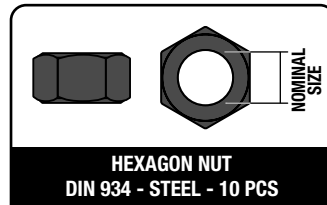

HEXAGON NUT
DIN 934 - STEEL - 10 PCS

REF	NOMINAL SIZE	COLOR
C-3103-20-6	M2	Black
C-3103-25-6	M2.5	Black
C-3103-30-6	M3	Black
C-3103-40-6	M4	Black
C-3103-50-6	M5	Black

BALL BEARINGS

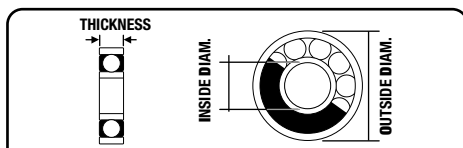

BALL BEARING
ABEC 3 - STEEL - 2 PCS

REF	ID MM	OD MM	TH MM
C-3611-3-05-08-03	5	8	3
C-3611-3-05-10-04	5	10	4
C-3611-3-06-10-03	6	10	3
C-3611-3-08-16-05	8	16	5
C-3611-3-10-15-04	10	15	4
C-3611-3-12-21-05	12	21	5

SHIMS

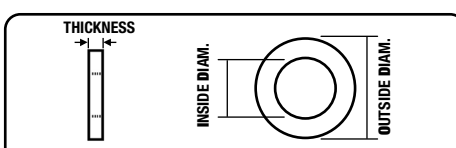

SHIM WASHERS
METRIC - STEEL - 10 PCS

REF	ID MM	OD MM	TH MM
C-3301-04-06-01	4	6	0.1
C-3301-06-08-01	6	8	0.1
C-3301-08-10-01	8	10	0.1
C-3301-13-16-01	13	16	0.1

STEELWASHERS

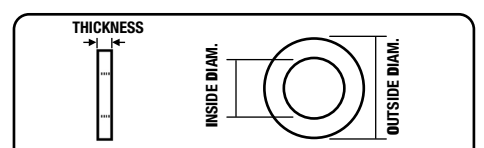

STEEL WASHERS
GALVANIZED STEEL - 10 PCS

REF	ID MM	OD MM	TH MM
C-3201-30	3.2	7	0.5
C-3201-40	4.3	9	0.8
C-3201-60	6.4	12	1.6

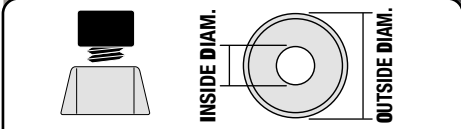
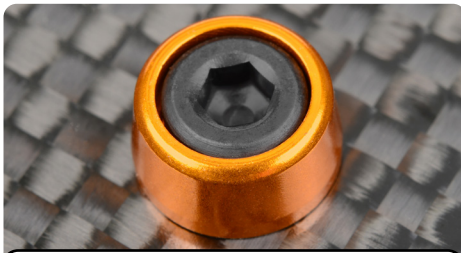

WASHER FOR SOCKET HEAD SCREW
ALUMINIUM - 10 PCS

REF	FOR S/H SCREW	ID MM	OD MM	COLOR
C-3214-20-0	M2	2.2	6	Gold
C-3214-20-1	M2	2.2	6	Green
C-3214-20-2	M2	2.2	6	Purple
C-3214-20-3	M2	2.2	6	Gun
C-3214-20-4	M2	2.2	6	Blue
C-3214-20-5	M2	2.2	6	Red
C-3214-20-6	M2	2.2	6	Black
C-3214-25-0	M2.5	2.7	7	Gold
C-3214-25-1	M2.5	2.7	7	Green
C-3214-25-2	M2.5	2.7	7	Purple
C-3214-25-3	M2.5	2.7	7	Gun
C-3214-25-4	M2.5	2.7	7	Blue
C-3214-25-5	M2.5	2.7	7	Red
C-3214-25-6	M2.5	2.7	7	Black
C-3214-30-0	M3	3.2	8	Gold
C-3214-30-1	M3	3.2	8	Green
C-3214-30-2	M3	3.2	8	Purple
C-3214-30-3	M3	3.2	8	Gun
C-3214-30-4	M3	3.2	8	Blue
C-3214-30-5	M3	3.2	8	Red
C-3214-30-6	M3	3.2	8	Black
C-3214-40-0	M4	4.3	10	Gold
C-3214-40-1	M4	4.3	10	Green
C-3214-40-2	M4	4.3	10	Purple
C-3214-40-3	M4	4.3	10	Gun
C-3214-40-4	M4	4.3	10	Blue
C-3214-40-5	M4	4.3	10	Red
C-3214-40-6	M4	4.3	10	Black
C-3214-50-0	M5	5.3	10	Gold
C-3214-50-1	M5	5.3	10	Green
C-3214-50-2	M5	5.3	10	Purple
C-3214-50-3	M5	5.3	10	Gun
C-3214-50-4	M5	5.3	10	Blue
C-3214-50-5	M5	5.3	10	Red
C-3214-50-6	M5	5.3	10	Black

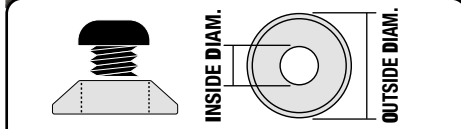

WASHER FOR BUTTON HEAD SCREW
ALUMINIUM - 10 PCS

REF	FOR B/H SCREW	ID MM	OD MM	COLOR
C-3211-30-0	M3	3.2	10	Gold
C-3211-30-1	M3	3.2	10	Green
C-3211-30-2	M3	3.2	10	Purple
C-3211-30-3	M3	3.2	10	Gun
C-3211-30-4	M3	3.2	10	Blue
C-3211-30-5	M3	3.2	10	Red
C-3211-30-6	M3	3.2	10	Black
C-3211-40-0	M4	4.3	12	Gold
C-3211-40-1	M4	4.3	12	Green
C-3211-40-2	M4	4.3	12	Purple
C-3211-40-3	M4	4.3	12	Gun
C-3211-40-4	M4	4.3	12	Blue
C-3211-40-5	M4	4.3	12	Red
C-3211-40-6	M4	4.3	12	Black

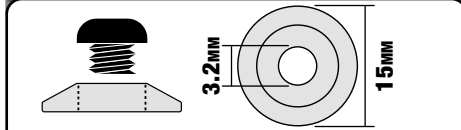

WASHER FOR BUTTON HEAD SCREW
ALUMINIUM - 10 PCS

REF	FOR B/H SCREW	ID MM	OD MM	COLOR
C-3212-30-0	M3	3.2	15	Gold
C-3212-30-1	M3	3.2	15	Green
C-3212-30-2	M3	3.2	15	Purple
C-3212-30-3	M3	3.2	15	Gun
C-3212-30-4	M3	3.2	15	Blue
C-3212-30-5	M3	3.2	15	Red
C-3212-30-6	M3	3.2	15	Black

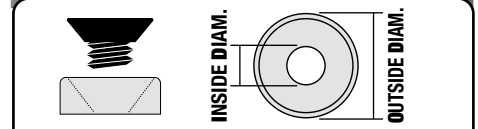
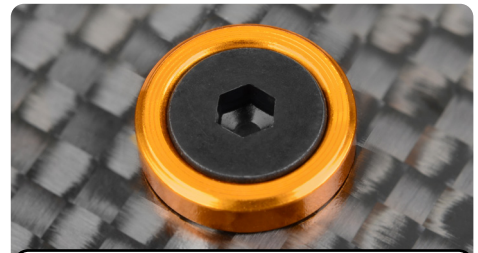

WASHER FOR FLAT HEAD SCREW
ALUMINIUM - 10 PCS

REF	FOR F/H SCREW	ID MM	OD MM	COLOR
C-3213-30-0	M3	3.2	8	Gold
C-3213-30-1	M3	3.2	8	Green
C-3213-30-2	M3	3.2	8	Purple
C-3213-30-3	M3	3.2	8	Gun
C-3213-30-4	M3	3.2	8	Blue
C-3213-30-5	M3	3.2	8	Red
C-3213-30-6	M3	3.2	8	Black
C-3213-40-0	M4	4.3	10	Gold
C-3213-40-1	M4	4.3	10	Green
C-3213-40-2	M4	4.3	10	Purple
C-3213-40-3	M4	4.3	10	Gun
C-3213-40-4	M4	4.3	10	Blue
C-3213-40-5	M4	4.3	10	Red
C-3213-40-6	M4	4.3	10	Black
C-3213-50-0	M5	5.3	12	Gold
C-3213-50-1	M5	5.3	12	Green
C-3213-50-2	M5	5.3	12	Purple
C-3213-50-3	M5	5.3	12	Gun
C-3213-50-4	M5	5.3	12	Blue
C-3213-50-5	M5	5.3	12	Red
C-3213-50-6	M5	5.3	12	Black

DECLARATION OF CONFORMITY

EU-Konformitätserklärung/ Déclaration de Conformité UE

(in accordance with ISO/IEC 17050-1) / (in Übereinstimmung mit ISO/IEC 17050-1) /
(Conformément à la norme ISO/IEC 17050-1)

Description : **1/8 JAMBO XP 6S - MONSTER TRUCK 4WD - RTR**
Item Number: **C-00166**

This declaration is issued under the sole responsibility of the manufacturer.
Die alleinige Verantwortung für die Ausstellung dieser Erklärung trägt der Hersteller.
La présente déclaration est établie sous la seule responsabilité du fabricant.

Product(s)/Produkt(e)/ Produit(s) : **1/8 JAMBO XP 6S - MONSTER TRUCK 4WD - RTR**

The object of declaration described above is in conformity with the relevant Union harmonization Legislation, specifically the requirements of the specifications listed below, following the provisions of the European RED Directive 2014/53/EU:
Der Gegenstand dieser Erklärung ist konform mit den Harmonisierungsrechtsvorschriften der Europäischen Union, insbesondere mit den unten aufgeführten Bestimmungen, und folgt der europäischen RED Direktive 2014/53/EU:
L'objet de la déclaration décrit ci-dessus est conforme à la législation pertinente en matière d'harmonisation de l'Union européenne, en particulier les exigences des spécifications énumérées ci-dessous, conformément aux dispositions des directives européennes RED 2014/53/EU:

EN 300 440 V2.1.1:2017	EN 301 489-3 V1.6.1:2013
EN 301 489-1 V2.1.1:2017	EN 60950-1:2006+A11:2009+A1:2010+A12:2011+A2:2013
EN 62479:2010	EN 55024:2010+A1:2015
EN 55032:2015	EN 61000-3-3:2013
EN 61000-3-2:2014	

JSP GROUP INTL • Geelseweg, 80 • 2250 Olen • Belgium

Signed for and on behalf of/ Unterzeichnet für und im Namen von/ Signé pour et au nom de :

Place/Ort/Lieu and Date/Datum/Data : **Olen, Belgium, 15 September 2020**

Name/Nom: **Stefan Engelen**
Title/Titel/Titre : **Ceo**

Signature/Unterschrift :



FEDERAL COMMUNICATIONS COMMISSION

EQUIPMENT AUTHORIZATION is hereby issued to the named GRANTEE JSP GROUP INTL BVBA / CORALLY, and is VALID ONLY for the equipment identified hereon for use under the Commission's Rules and Regulations listed below.

FCC IDENTIFIER :	2ASZJ-VP010005
Name of Grantee :	JSP GROUP INTL BVBA / CORALLY
Equipment Class :	Part 15 Low Power Communication Device Transmitter
Notes :	VARIOPROP S2R
FCC Rules :	15C
Frequency Range (MHZ) :	2410.0 - 2480.0

FACTORY PRO TOOL



Factory Pro Tool - Hardened Tip - Alu Grip - Hex

TEAM CORALLY - SHOCK PLIERS

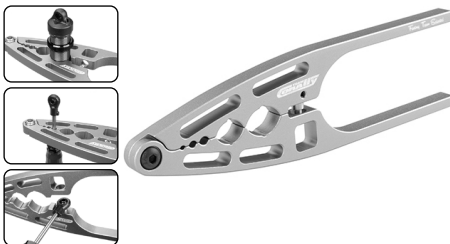

Team Corally - Shock Pliers

PINION CADDY M1.0

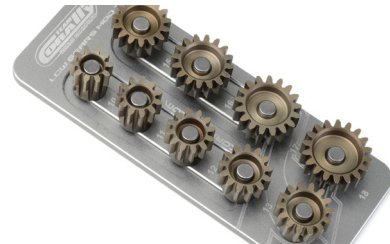

Team Corally - Pinion Caddy M1.0 - 9 Pinions - ø5mm

TEAM CORALLY - GREASE



Lithium Grease - Blue Grease - Ball Diff Grease - Copper Grease

TEAM CORALLY - SILICONE OILS



Shock Oils 60ml - 150ml - CST or WT - 100 >1000 CPS
Diff Oils 60ml - 2000 >2 000 000 CPS

TEAM PIT GEAR



A range of quality equipment for the transport and protection of your equipment.

TEAM CORALLY - PINIONS



Discover our range of Precision CNC-Cut MOD-1.0 Pinions for motors with a ø 5.0mm motor shaft

SPORT RACING - LIPO



Team Corally - Sport Racing 50C - 4S or 6S - XT-90 - Hard Case

ELECTRONIC

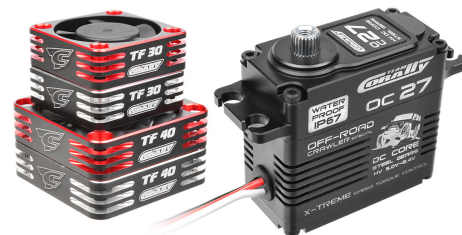

A range of high quality electronic equipment for the best performance.



Discover all these products and more on the website www.corally.com
Découvrez tous ces produits et bien plus encore sur le site web www.corally.com
 Entdecken Sie all diese Produkte und mehr auf der Website www.corally.com
 Ontdek al deze producten en meer op de website www.corally.com

This manual is an edition of Corally, a division of JSP GROUP INTL nv, Geelseweg 80, B-2250 Olen, Belgium. This manual is protected by a copyright and nothing from this edition may be reproduced or used without any prior written authorisation. Whilst every effort has been made to ensure the accuracy of the information in this manual, errors creep in and Corally can accept no responsibility for failures, wrong specifications, accuracy of colours, losses or damages caused. Corally denies any responsibility claims or damages caused by use of our products. Corally is not responsible for product / parts / specifications / Colour changes or availability of these products.

WWW.CORALLY.COM

TEAM
CORALLY

WORLD CHAMPIONS



WWW.CORALLY.COM

Team Corally is a registered trademark licensed to
JSP Group Intl bvba • Geelseweg 80 • B-2250 OLEN • Belgium
Tel: +32 14 25 92 94 • Info@corally.com